

Industrial Management Ethernet Switch

IES-3160 User's Manual



Version 1.4
Aug, 2019.



ORing Industrial Networking Corp.

4F., NO.3, Lane235, Baociao Rd.Sindian City,
Taipei County 23145 Taiwan, R.O.C.

Tel: + 886 2 2918 3036

Fax: + 886 2 2918 3084

Website: www.oring-networking.com

E-mail: support@oring-networking.com



Table of Content

Getting to Know Your Switch	4
1.1 About the IES-3160 Managed Industrial Switch.....	4
1.2 Software Features	4
1.3 Hardware Features.....	5
Hardware Installation	6
2.1 Installing Switch on DIN-Rail.....	6
2.1.1 Mount IES-3160 on DIN-Rail	6
2.2 Wall Mounting Installation.....	7
2.2.1 Mount IES-3160 on the wall.....	7
Hardware Overview	9
3.1 Front Panel	9
3.2 Front Panel LEDs	11
3.3 Top view Panel.....	11
3.4 Rear Panel.....	12
Cables	13
4.1 Ethernet Cables	13
4.1.1 100BASE-TX/10BASE-T Pin Assignments.....	13
4.1.2 100BASE-TX/10BASE-T Pin Assignments.....	14
4.2 Console Cable.....	15
WEB Management	16
5.1 Configuration by Web Browser	16
5.1.1 About Web-based Management.....	16
5.1.2 System Information	18
5.1.3 Front Panel.....	18
5.1.4 Basic setting.....	19
5.1.4.1 Switch Setting	19
5.1.4.2 Admin Password	20
5.1.4.3 IP Setting.....	20
5.1.4.4 SNTP (Time)	21
5.1.4.5 LLDP.....	24



- 5.1.4.6 Auto Provision 24
- 5.1.4.7 Backup & Restore 25
- 5.1.4.8 Upgrade Firmware 26
- 5.1.5 DHCP Server 26
 - 5.1.5.1 DHCP Server – Setting..... 26
 - 5.1.5.2 DHCP Server – Client List 27
 - 5.1.5.3 DHCP Server – Port and IP bindings 28
- 5.1.6 Port Setting 29
 - 5.1.6.1 Port Control..... 29
 - 5.1.6.2 Port Status 30
 - 5.1.6.3 Port Alias..... 30
 - 5.1.6.4 Rate Limit 31
 - 5.1.6.5 Port Trunk 32
- 5.1.7 Redundancy 34
 - 5.1.7.1 O-Ring..... 34
 - 5.1.7.2 RSTP 35
 - 5.1.7.3 MSTP 38
- 5.1.8 VLAN..... 42
 - 5.1.8.1 VLAN Setting 43
 - 5.1.8.2 VLAN Setting – Port Based..... 45
- 5.1.9 SNMP 47
 - 5.1.9.1 SNMP – Agent Setting 47
 - 5.1.9.2 SNMP – Trap Setting 48
- 5.1.10 Traffic Prioritization..... 49
- 5.1.11 Multicast 54
 - 5.1.11.1 IGMP Snooping..... 54
 - 5.1.11.2 MVR 55
 - 5.1.11.3 Multicast Filter 55
- 5.1.12 Security 57
 - 5.1.12.1 IP Security 57
 - 5.1.12.2 Port Security..... 58
 - 5.1.12.3 MAC Blacklist 59
 - 5.1.12.4 802.1x..... 59
- 5.1.13 Warning..... 63
 - 5.1.13.1 Fault Alarm 63
 - 5.1.13.2 System Alarm..... 64
- 5.1.14 Monitor and Diag..... 67



- 5.1.14.1 MAC Address Table 67
- 5.1.14.2 MAC Address Aging 68
- 5.1.14.3 Port Statistics 69
- 5.1.14.4 Port Monitoring 70
- 5.1.14.5 System Event Log 72
- 5.1.14.6 Ping 73
- 5.1.15 Save Configuration 73
- 5.1.16 Factory Default 74
- 5.1.17 System Reboot 74

Command Line Interface Management 75

- 6.1 About CLI Management 75
- 6.2 Commands Set List—System Commands Set 80
- 6.3 Commands Set List—Port Commands Set 82
- 6.4 Commands Set List—Trunk command set 85
- 6.5 Commands Set List—VLAN command set 86
- 6.6 Commands Set List—Spanning Tree command set 87
- 6.7 Commands Set List—QoS command set 89
- 6.8 Commands Set List—IGMP command set 90
- 6.9 Commands Set List—MAC/Filter Table command set 91
- 6.10 Commands Set List—SNMP command set 91
- 6.11 Commands Set List—Port Mirroring command set 92
- 6.12 Commands Set List—802.1x command set 93
- 6.13 Commands Set List—TFTP command set 95
- 6.14 Commands Set List—SYSLOG, SMTP, EVENT command set 96
- 6.15 Commands Set List—SNTP command set 97
- 6.16 Commands Set List—O-Ring command set 99

Technical Specifications 100

Getting to Know Your Switch

1.1 About the IES-3160 Managed Industrial Switch

The IES-3160 is powerful managed industrial switch with many features. The switch can work under wide temperature, dusty environment and humid condition. They can be managed by WEB, TELNET, Consol or other third-party SNMP software as well. Besides, the switch can be managed by a useful utility that we called Open-Vision. Open-Vision is powerful network management software. With its friendly and powerful interface, you can easily configure multiple switches at the same time, and monitor switches' status.

1.2 Software Features

- World's fastest Redundant Ethernet Ring (Recovery time < 10ms over 250 units connection)
- Supports Ring Coupling, Dual Homing over O-Ring
- Supports SNMPv1/v2/v3 & RMON & Port base/802.1Q VLAN Network Management
- Event notification by Email, SNMP trap and Relay Output
- Web-based ,Telnet, Console, CLI configuration
- Enable/disable ports, MAC based port security
- Port based network access control (802.1x)
- VLAN (802.1Q) to segregate and secure network traffic
- Radius centralized password management
- SNMPv3 encrypted authentication and access security
- RSTP (802.1w)
- Quality of Service (802.1p) for real-time traffic
- VLAN (802.1Q) with double tagging and GVRP supported
- IGMP Snooping for multicast filtering
- Port configuration, status, statistics, mirroring, security
- Remote Monitoring (RMON)



1.3 Hardware Features

- Redundant two DC power inputs
- Wide Operating Temperature: -40 to 70°C
- Storage Temperature: -40 to 85°C
- Operating Humidity: 5% to 95%, non-condensing
- Casing: IP-30
- 10/100Base-T(X) Ethernet port
- Console Port
- Dimensions(W x D x H) :74.3 mm(W)x 109.2 mm(D)x 153.6 mm(H)

Hardware Installation

2.1 Installing Switch on DIN-Rail

Each switch has a DIN-Rail kit on rear panel. The DIN-Rail kit helps switch to fix on the DIN-Rail. It is easy to install the switch on the DIN-Rail:

2.1.1 Mount IES-3160 on DIN-Rail

Step 1: Slant the switch and mount the metal spring to DIN-Rail.



Step 2: Push the switch toward the DIN-Rail until you heard a “click” sound.

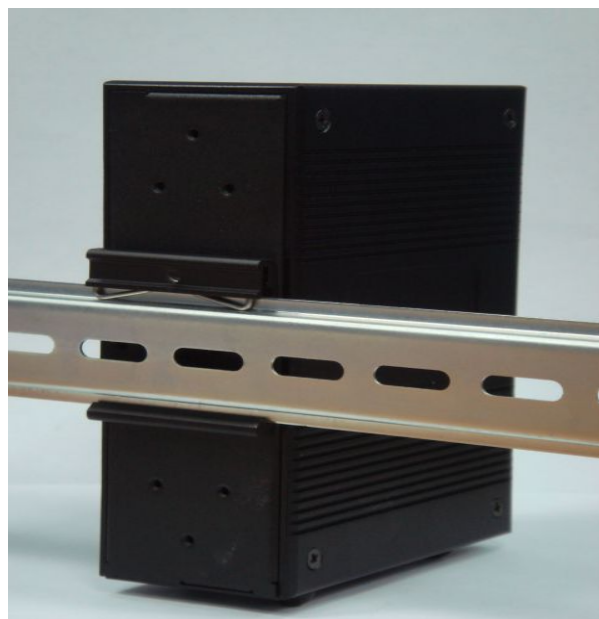

2.2 Wall Mounting Installation

Each switch has another installation method for users to fix the switch. A wall mount panel can be found in the package. The following steps show how to mount the switch on the wall.

2.2.1 Mount IES-3160 on the wall

Step 1: Remove DIN-Rail kit.

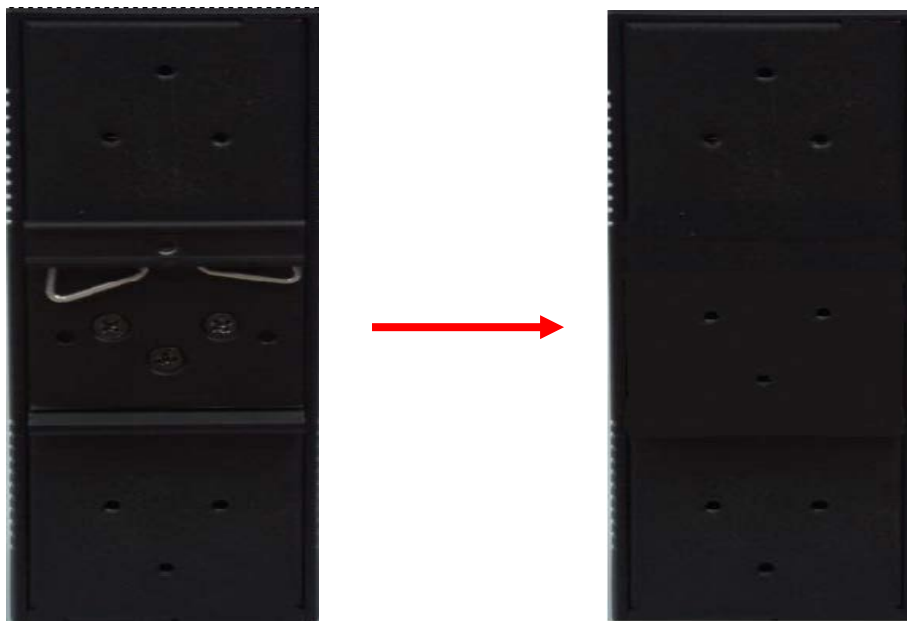

Step 2: Use 6 screws that can be found in the package to combine the wall mount panel. Just like the picture shows below:



The screws specification shows in the following two pictures. In order to prevent switch from any damage, the screws should not larger than the size that used in IES-3160 switch.

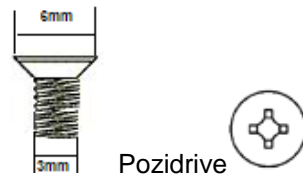

Step 3: Mount the combined switch on the wall.



Hardware Overview

3.1 Front Panel

The following table describes the labels that stick on the IES-3160.

Port	Description
10/100 RJ-45 fast Ethernet ports	16 10/100Base-T(X) RJ-45 fast Ethernet ports support auto-negotiation. Default Setting : Speed: auto Duplex: auto Flow control : disable
Console	Use RS-232 to RJ-45 connector to manage switch.
Reset	Push reset button 2 to 3 seconds to reset the switch. Push reset button 5 seconds to reset the switch into Factory Default .

IES-3160

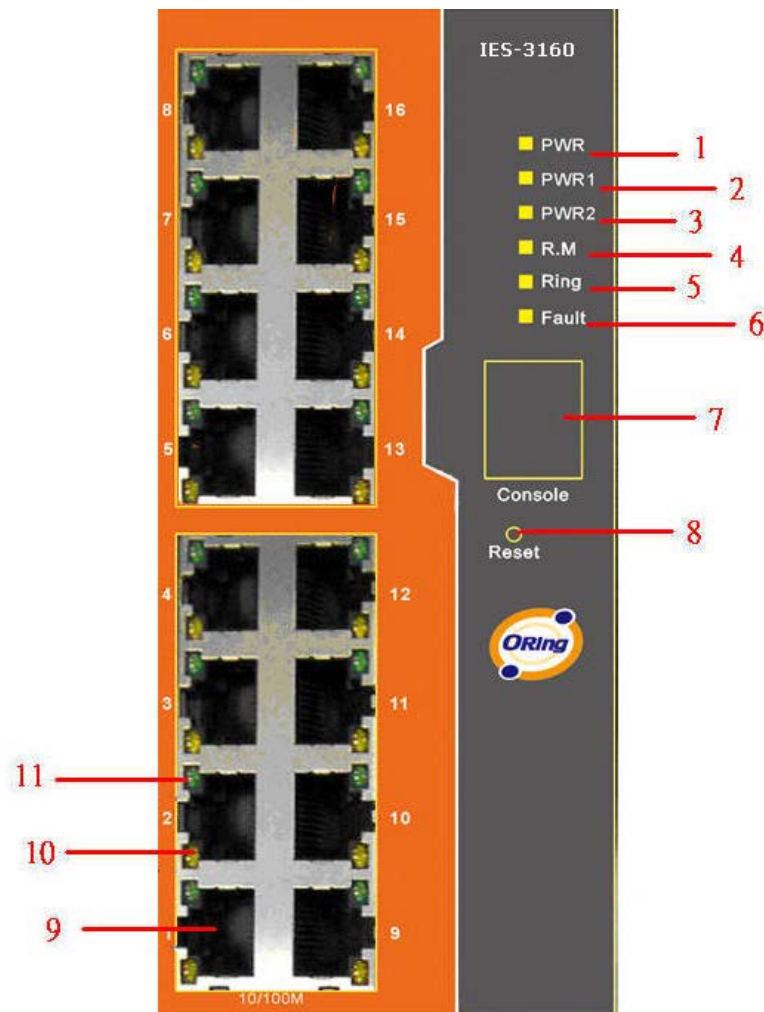

1. LED for PWR. When the PWR links, the green led will be light on.
2. LED for PWR1. When the PWR1 links, the green led will be light on.
3. LED for PWR2. When the PWR2 links, the green led will be light on.
4. LED for R.M (Ring master). When the LED light on, it means that the switch is the ring master of O-Ring.
5. LED for Ring. When the led light on, it means the O-Ring is activated.
6. LED for Fault Relay. When the fault occurs, the amber LED will be light on.
7. . Console port (RJ-45).
8. Reset button. Push the button 3 seconds for reset; 5 seconds for factory default.
9. 10/100Base-T(X) Ethernet ports.
10. LED for Ethernet ports speed.
11. LED for Ethernet ports link status.

3.2 Front Panel LEDs

LED	Color	Status	Description
PWR	Green	On	DC power ready
PW1	Green	On	DC power module 1 activated.
PW2	Green	On	DC power module 2 activated.
R.M	Green	On	O-Ring Master.
Fault	Amber	On	Fault relay. Power failure or Port down/fail.
10/100Base-T(X) Fast Ethernet ports			
LNK / ACT	Green	On	Port link up.
		Blinking	Data transmitted.
Full Duplex	Amber	On	Port works under full duplex.

3.3 Top view Panel

The bottom panel components of IES-3160 are shown as below:

1. Terminal block includes: PWR1, PWR2 (48V DC)
2. Ground wire

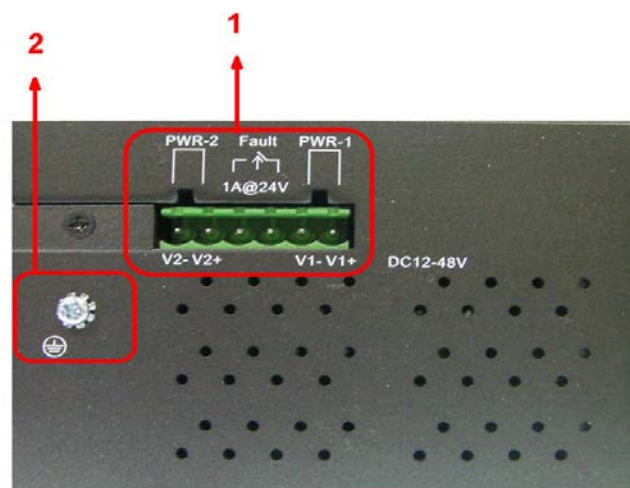

3.4 Rear Panel

The components in the rear of IES-3160 are shown as below:

1. Screw holes for wall mount kit.
2. DIN-Rail kit

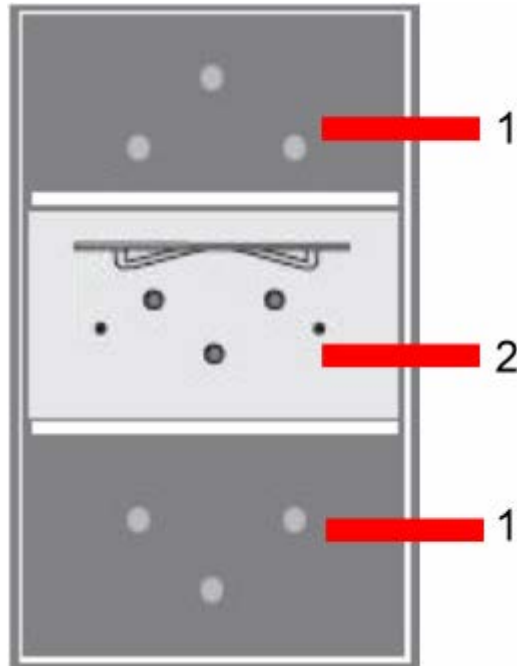

Cables

4.1 Ethernet Cables

The IES-3160 switch has standard Ethernet ports. According to the link type, the switch use CAT 3, 4, 5, 5e UTP cables to connect to any other network device (PCs, servers, switches, routers, or hubs). Please refer to the following table for cable specifications.

Cable Types and Specifications

Cable	Type	Max. Length	Connector
10BASE-T	Cat.3, 4, 5 100-ohm	UTP 100 m (328 ft)	RJ-45
100BASE-TX	Cat.5 100-ohm UTP	UTP 100 m (328 ft)	RJ-45

4.1.1 100BASE-TX/10BASE-T Pin Assignments

The IES-3160 switch have standard Ethernet ports. According to the link type, the switch use CAT 3, 4, 5, 5e UTP cables to connect to any other network device (PCs, servers, switches, routers, or hubs). Please refer to the following table for cable specifications.

Cable Types and Specifications

Cable	Type	Max. Length	Connector
10BASE-T	Cat.3, 4, 5 100-ohm	UTP 100 m (328 ft)	RJ-45
100BASE-TX	Cat.5 100-ohm UTP	UTP 100 m (328 ft)	RJ-45

4.1.2 100BASE-TX/10BASE-T Pin Assignments

With 100BASE-TX/10BASE-T cable, pins 1 and 2 are used for transmitting data, and pins 3 and 6 are used for receiving data.

RJ-45 Pin Assignments

Pin Number	Assignment
1	TD+
2	TD-
3	RD+
4	Not used
5	Not used
6	RD-
7	Not used
8	Not used

The IES-3160 switch support auto MDI/MDI-X operation. You can use a straight-through cable to connect PC to switch. The following table below shows the 10BASE-T/ 100BASE-TX MDI and MDI-X port pin outs.

MDI/MDI-X pins assignment

Pin Number	MDI port	MDI-X port
1	TD+(transmit)	RD+(receive)
2	TD-(transmit)	RD-(receive)
3	RD+(receive)	TD+(transmit)
4	Not used	Not used
5	Not used	Not used
6	RD-(receive)	TD-(transmit)
7	Not used	Not used
8	Not used	Not used

Note: “+” and “-” signs represent the polarity of the wires that make up each wire pair.

4.2 Console Cable

IES-3160 switch can be management by console port. The DB-9 to RJ-45 cable can be found in the package. You can connect them to PC via a RS-232 cable with DB-9 female connector and the other end (RJ-45 connector) connects to console port of switch.

PC pin out (male) assignment	RS-232 with DB9 female connector	DB9 to RJ 45
Pin #2 RD	Pin #2 TD	Pin #2
Pin #3 TD	Pin #3 RD	Pin #3
Pin #5 GD	Pin #5 GD	Pin #5

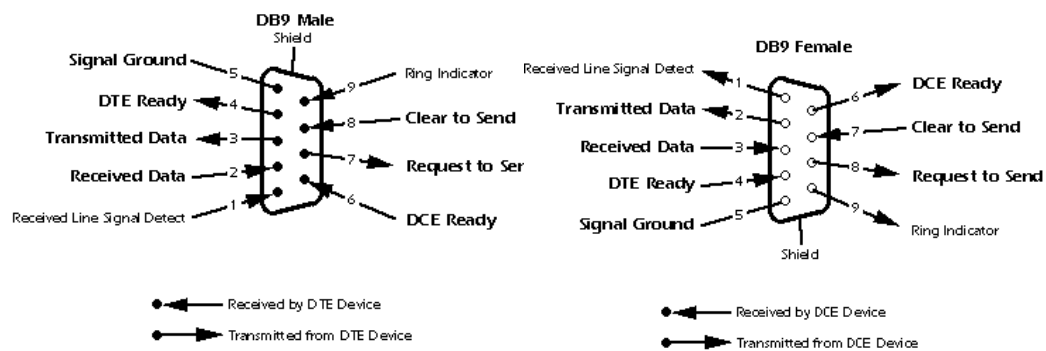

WEB Management



5.1 Configuration by Web Browser

This section introduces the configuration by Web browser.

5.1.1 About Web-based Management

An embedded HTML web site resides in flash memory on the CPU board. It contains advanced management features and allows you to manage the switch from anywhere on the network through a standard web browser such as Microsoft Internet Explorer.

The Web-Based Management function supports Internet Explorer 5.0 or later. It is based on Java Applets with an aim to reduce network bandwidth consumption, enhance access speed and present an easy viewing screen.

Note: By default, IE5.0 or later version does not allow Java Applets to open sockets. You need to explicitly modify the browser setting in order to enable Java Applets to use network ports.

Preparing for Web Management

The default value is as below:

IP Address: **192.168.10.1**

Subnet Mask: **255.255.255.0**

Default Gateway: **192.168.10.254**

User Name: **admin**

Password: **admin**

System Login

1. Launch the Internet Explorer.
2. Type http:// and the IP address of the switch. Press "Enter".

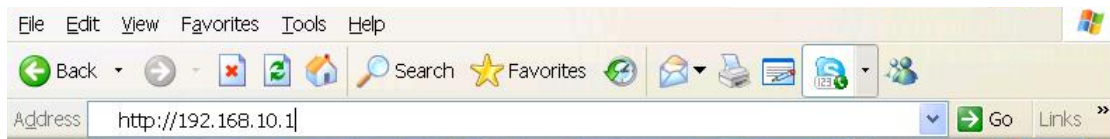

3. The login screen appears.
4. Key in the username and password. The default username and password is "admin".
5. Click "Enter" or "OK" button, then the main interface of the Web-based management appears.

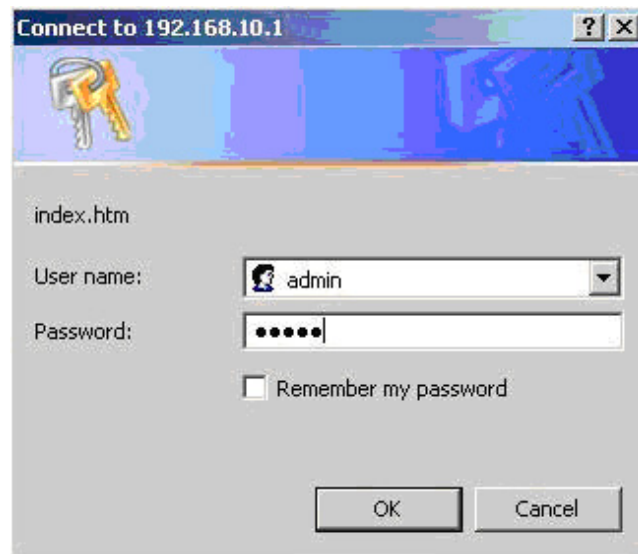

Login screen

Main Interface

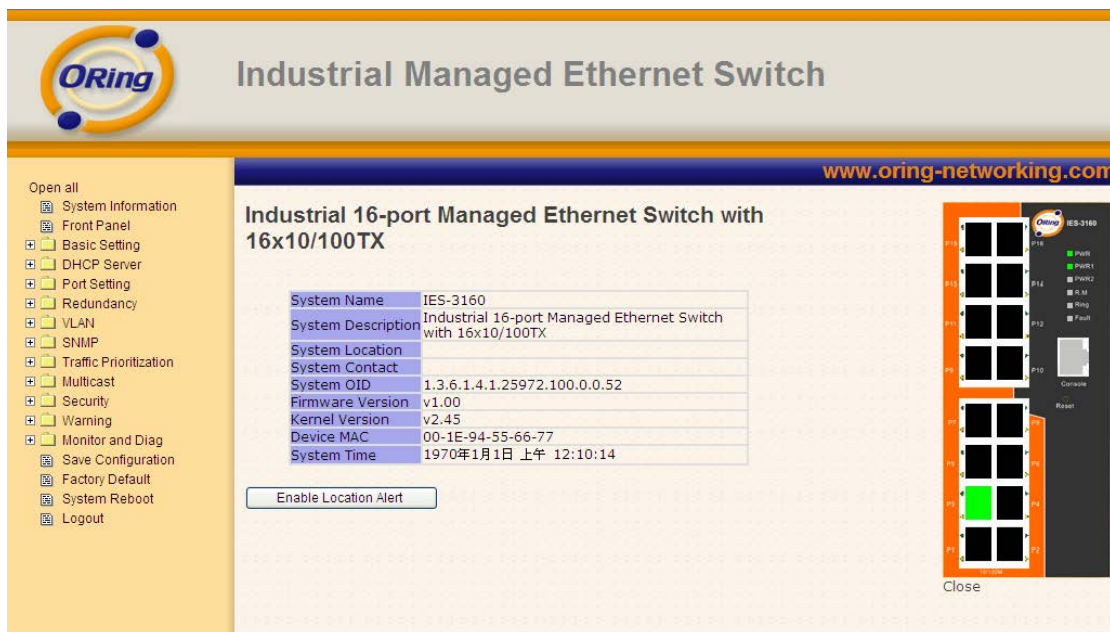

Main interface

5.1.2 System Information

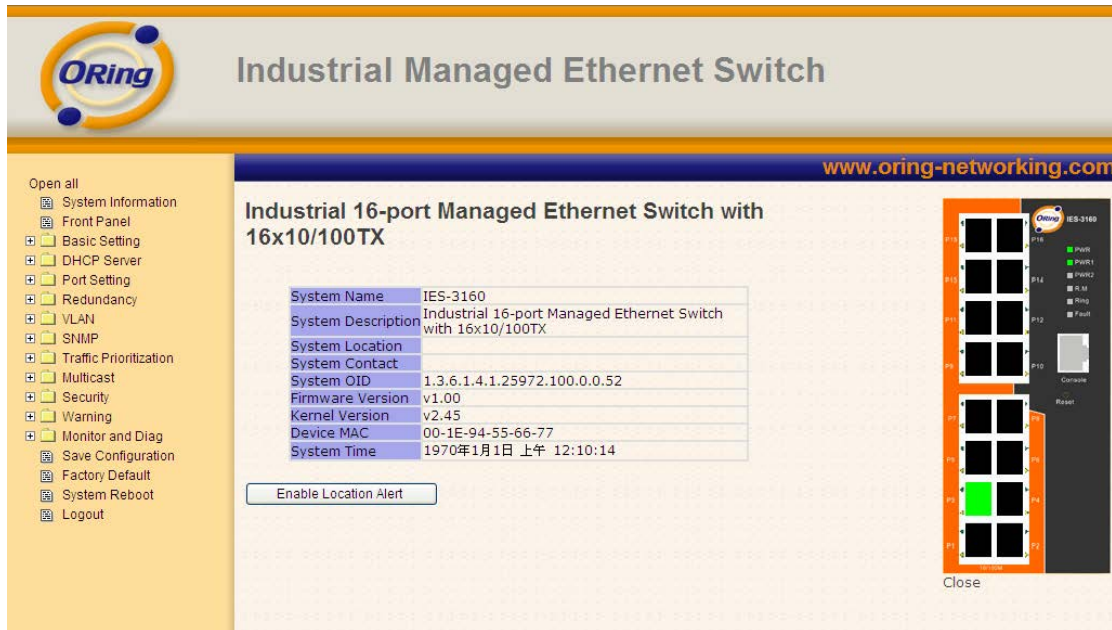

System Information interface

System Information

The system information will display the configuration of Basic Setting / Switch Setting page.

Enable Location Alert

When click , PWR1 and PWR2 LEDs of the switch will start to flash together, and click , the LEDs will stop flashing.

5.1.3 Front Panel

Show the panel of IES-3160. Click "Close" to close panel on web.

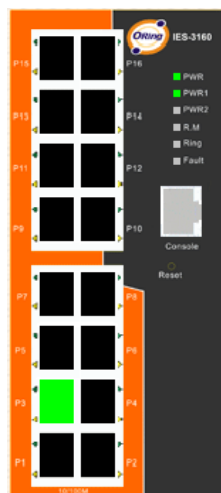

5.1.4 Basic setting

5.1.4.1 Switch Setting

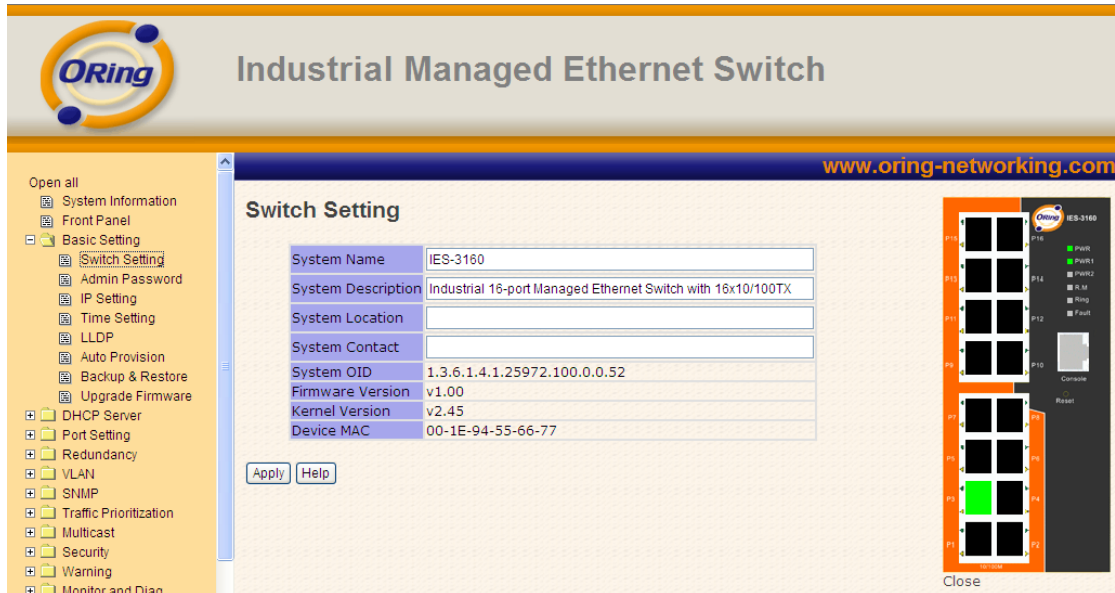

Switch setting interface

The following table describes the labels in this screen.

Label	Description
System Name	Assign the name of switch. The maximum length is 64 bytes
System Description	Display the description of switch.
System Location	Assign the switch physical location. The maximum length is 64 bytes
System Contact	Enter the name of contact person or organization
System OID	Display the switch's OID information
Firmware Version	Display the switch's firmware version
Kernel Version	Display the kernel software version
MAC Address	Display the unique hardware address assigned by manufacturer (default)

5.1.4.2 Admin Password

Change web management login username and password for the management security issue

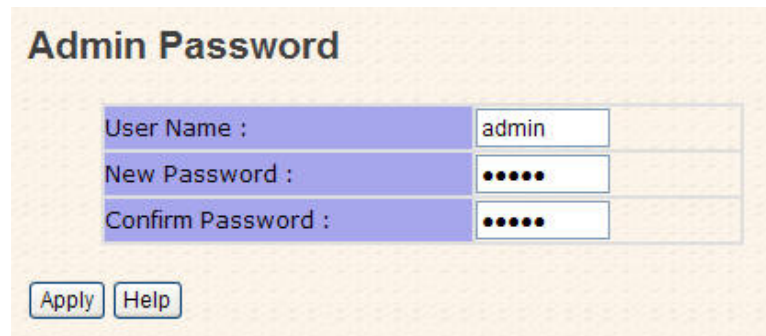

The screenshot shows the 'Admin Password' configuration page. It features three input fields: 'User Name' with the value 'admin', 'New Password' with masked characters '•••••', and 'Confirm Password' also with masked characters '•••••'. Below the fields are two buttons: 'Apply' and 'Help'.

Admin Password interface

The following table describes the labels in this screen.

Label	Description
User name	Key in the new username (The default is “ admin ”)
New Password	Key in the new password (The default is “ admin ”)
Confirm password	Re-type the new password.
Apply	Click “ Apply ” to activate the configurations.

5.1.4.3 IP Setting

You can configure the IP Settings and DHCP client function through IP configuration.

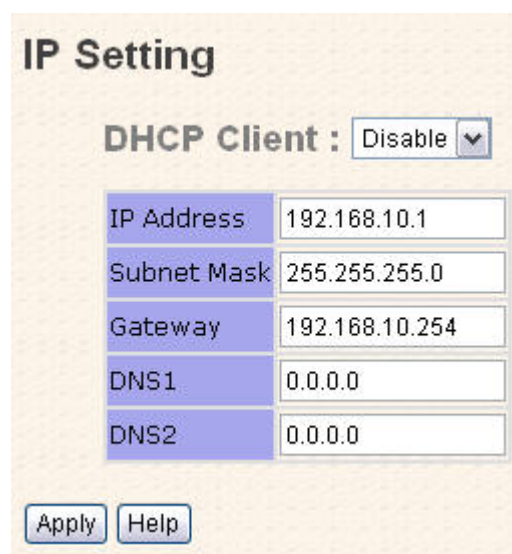

The screenshot shows the 'IP Setting' configuration page. At the top, there is a 'DHCP Client' dropdown menu set to 'Disable'. Below this are five input fields: 'IP Address' (192.168.10.1), 'Subnet Mask' (255.255.255.0), 'Gateway' (192.168.10.254), 'DNS1' (0.0.0.0), and 'DNS2' (0.0.0.0). At the bottom are 'Apply' and 'Help' buttons.

IP Configuration interface

The following table describes the labels in this screen.

Label	Description
DHCP Client	To enable or disable the DHCP client function. When DHCP client function is enabling, the switch will be assigned the IP address from the network DHCP server. The default IP address will be replaced by the IP address which the DHCP server has assigned. After clicking " Apply " button, a popup dialog shows up to inform when the DHCP client is enabling. The current IP will lose and you should find a new IP on the DHCP server.
IP Address	Assign the IP address that the network is using. If DHCP client function is enabling, you do not need to assign the IP address. The network DHCP server will assign the IP address for the switch and it will be display in this column. The default IP is 192.168.10.1
Subnet Mask	Assign the subnet mask of the IP address. If DHCP client function is enabling, you do not need to assign the subnet mask
Gateway	Assign the network gateway for the switch. The default gateway is 192.168.10.254
DNS1	Assign the primary DNS IP address
DNS2	Assign the secondary DNS IP address
Apply	Click " Apply " to activate the configurations.

5.1.4.4 SNTP (Time)

The SNTP (Simple Network Time Protocol) settings allow you to synchronize switch clocks in the Internet.

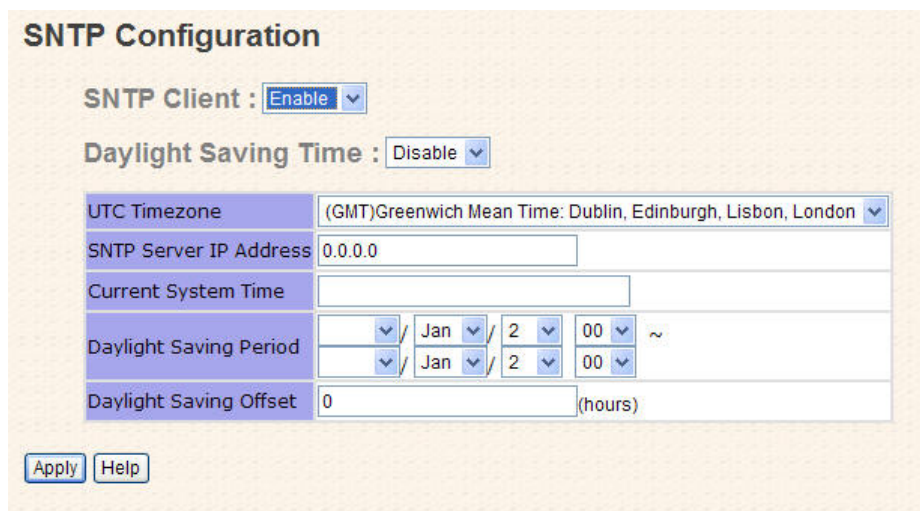

SNTP Configuration interface



The following table describes the labels in this screen.

Label	Description
SNTP Client	Enable or disable SNTP function to get the time from the SNTP server.
Daylight Saving Time	Enable or disable daylight saving time function. When daylight saving time is enabling, you need to configure the daylight saving time period.
UTC Time zone	Set the switch location time zone. The following table lists the different location time zone for your reference.

Local Time Zone	Conversion from UTC	Time at 12:00 UTC
November Time Zone	- 1 hour	11 am
Oscar Time Zone	-2 hours	10 am
ADT - Atlantic Daylight	-3 hours	9 am
AST - Atlantic Standard EDT - Eastern Daylight	-4 hours	8 am
EST - Eastern Standard CDT - Central Daylight	-5 hours	7 am
CST - Central Standard MDT - Mountain Daylight	-6 hours	6 am
MST - Mountain Standard PDT - Pacific Daylight	-7 hours	5 am
PST - Pacific Standard ADT - Alaskan Daylight	-8 hours	4 am
ALA - Alaskan Standard	-9 hours	3 am
HAW - Hawaiian Standard	-10 hours	2 am
Nome, Alaska	-11 hours	1 am



CET - Central European FWT - French Winter MET - Middle European MEWT - Middle European Winter SWT - Swedish Winter	+1 hour	1 pm
EET - Eastern European, USSR Zone 1	+2 hours	2 pm
BT - Baghdad, USSR Zone 2	+3 hours	3 pm
ZP4 - USSR Zone 3	+4 hours	4 pm
ZP5 - USSR Zone 4	+5 hours	5 pm
ZP6 - USSR Zone 5	+6 hours	6 pm
WAST - West Australian Standard	+7 hours	7 pm
CCT - China Coast, USSR Zone 7	+8 hours	8 pm
JST - Japan Standard, USSR Zone 8	+9 hours	9 pm
EAST - East Australian Standard GST Guam Standard, USSR Zone 9	+10 hours	10 pm
IDLE - International Date Line NZST - New Zealand Standard NZT - New Zealand	+12 hours	Midnight

Label	Description
SNTP Sever IP Address	Set the SNTP server IP address.
Daylight Saving	Set up the Daylight Saving beginning time and Daylight Saving

Period	ending time. Both will be different each year.
Daylight Saving Offset	Set up the offset time.
Switch Timer	Display the switch current time.
Apply	Click " Apply " to activate the configurations.

5.1.4.5 LLDP

LLDP (Link Layer Discovery Protocol) function allows the switch to advertise its information to other nodes on the network and store the information it discovers.

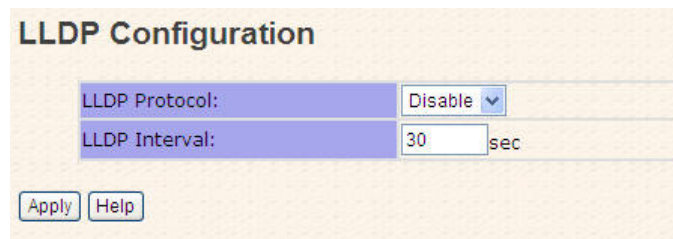

LLDP configuration interface

The following table describes the labels in this screen.

Label	Description
LLDP Protocol	" Enable " or " Disable " LLDP function.
LLDP Interval	The interval of resend LLDP (by default at 30 seconds)
Apply	Click " Apply " to activate the configurations.
Help	Show help file.

5.1.4.6 Auto Provision

Auto Provision allows you to update the switch firmware automatically. You can put firmware or configuration file on TFTP server. When you reboot the switch, it will upgrade automatically. Before updating, make sure you have your TFTP server ready and the firmware image and configuration file is on the TFTP server.

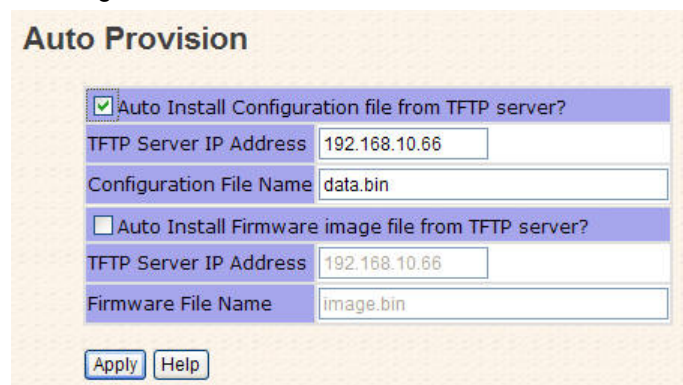

Auto Provision interface

5.1.4.7 Backup & Restore

You can save current configuration from the switch to TFTP server, or restore the configuration from TFTP server in this page.

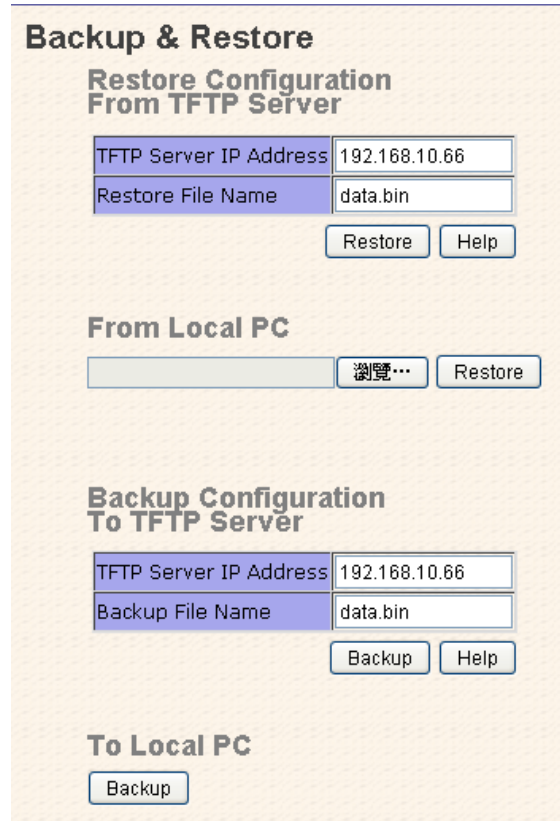

The screenshot shows a web interface titled "Backup & Restore". It is divided into four sections:

- Restore Configuration From TFTP Server:** Contains two input fields: "TFTP Server IP Address" (with value 192.168.10.66) and "Restore File Name" (with value data.bin). Below these are "Restore" and "Help" buttons.
- From Local PC:** Contains a file selection input field with a "瀏覽..." (Browse) button and a "Restore" button.
- Backup Configuration To TFTP Server:** Contains two input fields: "TFTP Server IP Address" (with value 192.168.10.66) and "Backup File Name" (with value data.bin). Below these are "Backup" and "Help" buttons.
- To Local PC:** Contains a single "Backup" button.

Backup & Restore interface

The following table describes the labels in this screen.

Label	Description
TFTP Server IP Address	Fill in the TFTP server IP
Restore File Name	Fill the file name.
Restore	Click " restore " to restore the configurations.
Restore File Name	Fill the file name.
Restore	Click " restore " to restore the configurations.
Backup	Click " backup " to backup the configurations.

5.1.4.8 Upgrade Firmware

Upgrade Firmware allows you to update the firmware of switch. Before updating, make sure you have your TFTP server ready and the firmware image is on the TFTP server.

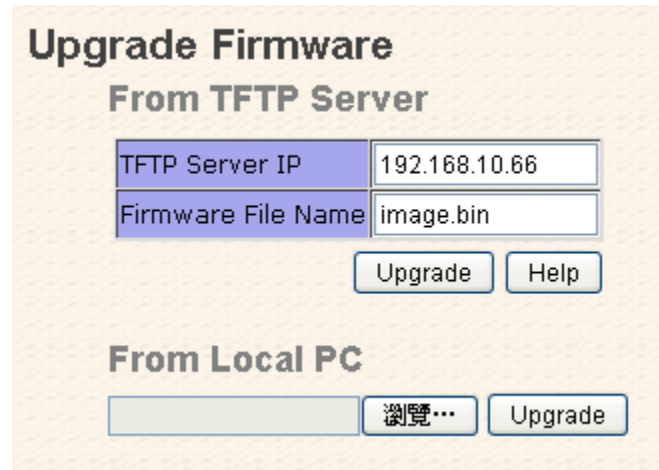

Update Firmware interface

5.1.5 DHCP Server

5.1.5.1 DHCP Server – Setting

The system provides with DHCP server function. Enable the DHCP server function, the switch system will be a DHCP server.

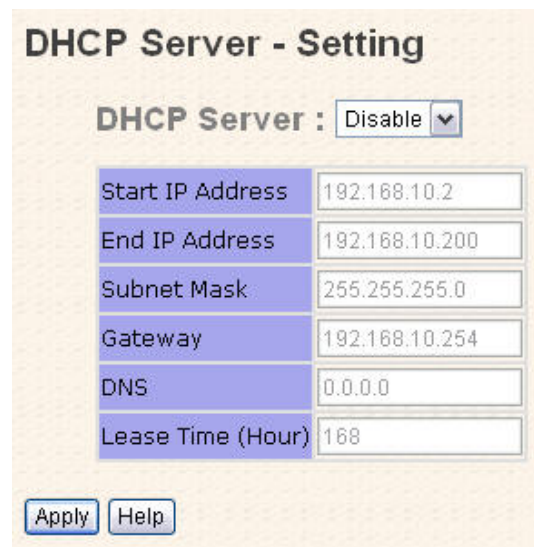

DHCP Server Configuration interface

The following table describes the labels in this screen.

Label	Description
DHCP Server	Enable or Disable the DHCP Server function. Enable – the switch will be the DHCP server on your local network

Start IP Address	The dynamic IP assign range. Low IP address is the beginning of the dynamic IP assigns range. For example: dynamic IP assign range is from 192.168.1.100 to 192.168.1.200. 192.168.1.100 will be the Start IP address.
End IP Address	The dynamic IP assign range. High IP address is the end of the dynamic IP assigns range. For example: dynamic IP assign range is from 192.168.1.100 to 192.168.1.200. 192.168.1.200 will be the End IP address
Subnet Mask	The dynamic IP assign range subnet mask
Gateway	The gateway in your network.
DNS	Domain Name Server IP Address in your network.
Lease Time (Hour)	It is the period that system will reset the assigned dynamic IP to ensure the IP address is in used.
Apply	Click " Apply " to activate the configurations.

5.1.5.2 DHCP Server – Client List

When the DHCP server function is activated, the system will collect the DHCP client information and display in here.

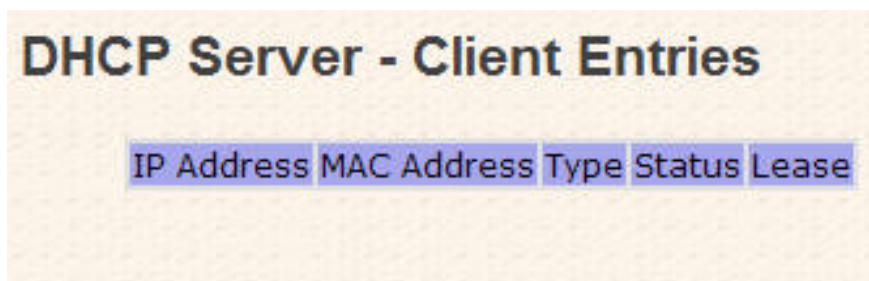

DHCP Server Client Entries interface

5.1.5.3 DHCP Server – Port and IP bindings

You can assign the specific IP address which is in the assigned dynamic IP range to the specific port. When the device is connecting to the port and asks for dynamic IP assigning, the system will assign the IP address that has been assigned before in the connected device.

DHCP Server - Port and IP Binding

Port No.	IP Address
Port.01	<input type="text" value="0.0.0.0"/>
Port.02	<input type="text" value="0.0.0.0"/>
Port.03	<input type="text" value="0.0.0.0"/>
Port.04	<input type="text" value="0.0.0.0"/>
Port.05	<input type="text" value="0.0.0.0"/>
Port.06	<input type="text" value="0.0.0.0"/>
Port.07	<input type="text" value="0.0.0.0"/>
Port.08	<input type="text" value="0.0.0.0"/>
Port.09	<input type="text" value="0.0.0.0"/>
Port.10	<input type="text" value="0.0.0.0"/>
Port.11	<input type="text" value="0.0.0.0"/>
Port.12	<input type="text" value="0.0.0.0"/>
Port.13	<input type="text" value="0.0.0.0"/>
Port.14	<input type="text" value="0.0.0.0"/>
Port.15	<input type="text" value="0.0.0.0"/>
Port.16	<input type="text" value="0.0.0.0"/>

DHCP Server Port and IP Binding interface

5.1.6 Port Setting

5.1.6.1 Port Control

By this function, you can set the state, speed/duplex, flow control, and security of the port.

Port Control

Port No.	State	Speed/Duplex	Flow Control	Security
Port.01	Enable	AutoNegotiation	Symmetric	Disable
Port.02	Enable	AutoNegotiation	Symmetric	Disable
Port.03	Enable	AutoNegotiation	Symmetric	Disable
Port.04	Enable	AutoNegotiation	Symmetric	Disable
Port.05	Enable	AutoNegotiation	Symmetric	Disable
Port.06	Enable	AutoNegotiation	Symmetric	Disable
Port.07	Enable	AutoNegotiation	Symmetric	Disable
Port.08	Enable	AutoNegotiation	Symmetric	Disable
Port.09	Enable	AutoNegotiation	Symmetric	Disable
Port.10	Enable	AutoNegotiation	Symmetric	Disable
Port.11	Enable	AutoNegotiation	Symmetric	Disable
Port.12	Enable	AutoNegotiation	Symmetric	Disable
Port.13	Enable	AutoNegotiation	Symmetric	Disable
Port.14	Enable	AutoNegotiation	Symmetric	Disable
Port.15	Enable	AutoNegotiation	Symmetric	Disable
Port.16	Enable	AutoNegotiation	Symmetric	Disable

Apply Help

Port Control interface

The following table describes the labels in this screen.

Label	Description
Port NO.	Port number for setting.
Speed/Duplex	You can set Auto-negotiation, 100 full, 100 half, 10 full or 10 half
Flow Control	Support symmetric and asymmetric mode to avoid packet loss when congestion occurred.
Security	Support port security function. When enable the function, the port will STOP learning MAC address dynamically.
Apply	Click " Apply " to activate the configurations.

5.1.6.2 Port Status

The following information provides the current port status information

Port Status

Port No.	Type	Link	State	Speed/Duplex	Flow Control
Port.01	100TX	Down	Enable	N/A	N/A
Port.02	100TX	Down	Enable	N/A	N/A
Port.03	100TX	UP	Enable	100 Full	Enable
Port.04	100TX	Down	Enable	N/A	N/A
Port.05	100TX	Down	Enable	N/A	N/A
Port.06	100TX	Down	Enable	N/A	N/A
Port.07	100TX	Down	Enable	N/A	N/A
Port.08	100TX	Down	Enable	N/A	N/A
Port.09	100TX	Down	Enable	N/A	N/A
Port.10	100TX	Down	Enable	N/A	N/A
Port.11	100TX	Down	Enable	N/A	N/A
Port.12	100TX	Down	Enable	N/A	N/A
Port.13	100TX	Down	Enable	N/A	N/A
Port.14	100TX	Down	Enable	N/A	N/A
Port.15	100TX	Down	Enable	N/A	N/A
Port.16	100TX	Down	Enable	N/A	N/A

Port Status interface

5.1.6.3 Port Alias

The user can define the name of every Port. Can let user, convenient management every Port.

Port Alias

Port No.	Port Alias
Port.01	<input type="text"/>
Port.02	<input type="text"/>
Port.03	<input type="text"/>
Port.04	<input type="text"/>
Port.05	<input type="text"/>
Port.06	<input type="text"/>
Port.07	<input type="text"/>
Port.08	<input type="text"/>
Port.09	<input type="text"/>
Port.10	<input type="text"/>
Port.11	<input type="text"/>

5.1.6.4 Rate Limit

By this function, you can limit traffic of all ports, including broadcast, multicast and flooded Unicast. You can also set "Ingress" or "Egress" to limit traffic received or transmitted bandwidth.

Rate Limit

Port No.	Ingress Limit Frame Type	Ingress	Egress
Port.01	All	0 kbps	0 kbps
Port.02	All	0 kbps	0 kbps
Port.03	All	0 kbps	0 kbps
Port.04	All	0 kbps	0 kbps
Port.05	All	0 kbps	0 kbps
Port.06	All	0 kbps	0 kbps
Port.07	All	0 kbps	0 kbps
Port.08	All	0 kbps	0 kbps
Port.09	All	0 kbps	0 kbps
Port.10	All	0 kbps	0 kbps
Port.11	All	0 kbps	0 kbps
Port.12	All	0 kbps	0 kbps
Port.13	All	0 kbps	0 kbps
Port.14	All	0 kbps	0 kbps
Port.15	All	0 kbps	0 kbps
Port.16	All	0 kbps	0 kbps

Rate range is from 100 kbps to 102400 kbps (i.e. 100Mbps) for mega-ports, or 256000 kbps (i.e. 250Mbps) for giga-ports. Zero means no limit.

Rate Limit interface

The following table describes the labels in this screen.

Label	Description
Ingress Limit Frame Type	You can set "all", "Broadcast only", "Broadcast/Multicast" or "Broadcast/Multicast/Flooded Unicast" mode.
Ingress	The switch port received traffic.
Egress	The switch port transmitted traffic.
Apply	Click "Apply" to activate the configurations.

5.1.6.5 Port Trunk

Port Trunk – Setting

You can select static trunk or 802.3ad LACP to combine several physical links with a logical link to increase the bandwidth.

Port Trunk - Setting

Port No.	Group ID	Type
Port.01	None	Static
Port.02	None	Static
Port.03	None	Static
Port.04	None	Static
Port.05	None	Static
Port.06	None	Static
Port.07	None	Static
Port.08	None	Static
Port.09	None	Static
Port.10	None	Static
Port.11	None	Static
Port.12	None	Static
Port.13	None	Static
Port.14	None	Static
Port.15	None	Static
Port.16	None	Static

Note: the types should be the same for all member ports in a group.

802.3ad LACP Work Ports

Group ID	Work Ports
Trunk1	max
Trunk2	max
Trunk3	max
Trunk4	max
Trunk5	max
Trunk6	max
Trunk7	max
Trunk8	max

Apply Help

Port Trunk - Setting interface

The following table describes the labels in this screen.

Label	Description
Group ID	Select port to join a trunk group.
Type	Support static trunk and 802.3ad LACP
Apply	Click “ Apply ” to activate the configurations.

Port Trunk – Status

You can check the configuration of port trunk.



Group ID	Trunk Member	Type
Trunk 1		Static
Trunk 2		Static
Trunk 3		Static
Trunk 4		Static
Trunk 5		Static
Trunk 6		Static
Trunk 7		Static
Trunk 8		Static

Port Trunk - Status interface

5.1.7 Redundancy

5.1.7.1 O-Ring

O-Ring is one of the most powerful Redundant Ring technologies in the world. The recovery time of O-Ring is less than 10 ms over 250 units of connections. It can reduce unexpected malfunction caused by network topology change. O-Ring technology supports three Ring topologies for network redundancy: O-Ring, Coupling Ring and Dual Homing.

O-Ring

O-Ring

Coupling Ring

Dual Homing

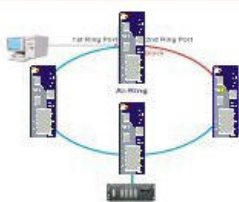

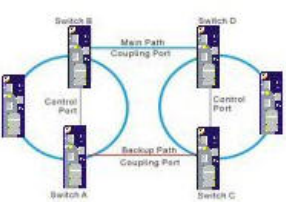

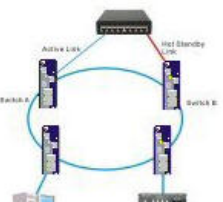

Ring Master	Disable	Coupling Port	Port.03
1st Ring Port	Port.01	Control Port	Port.04
2nd RingPort	Port.02		

Apply
Help

* Connect to other vendor's ring...

O-Ring interface

The following table describes the labels in this screen.

Label	Description
O-Ring	To enable O-Ring.
Ring Master	There should be one and only one Ring Master in a ring. However if there are two or more switches which set Ring Master to enable, the switch with the lowest MAC address will be the actual Ring Master and others will be Backup Masters.
1st Ring Port	The primary port, when this switch is configured in O-Ring.
2nd Ring Port	The backup port, when this switch is configured in O-Ring.
Coupling Ring	To enable Coupling Ring. Coupling Ring can be used to divide a big ring into two smaller Rings to avoid effecting all switches when network topology change. It is a good application for connecting two Rings.
Coupling Port	Set a port as coupling port to link to the Coupling Port of the switch in another ring. Coupling Ring need four switch to

	construct an active and a backup link. The coupled four ports of four switches will be operated at active/backup mode.
Control Port	Set a port as Control Port to link to the Control Port of the switch in the same ring. Control Port used to transmit control signals.
Dual Homing	To enable Dual Homing. By selecting Dual Homing mode, Ring will be connected to normal switches through two RSTP links (i.e., backbone Switch). The two links act as active/backup mode, and connect each Ring to the normal switches in RSTP mode.
Apply	Click " Apply " to activate the configurations.

Note: It is not recommended to set one switch as a Ring Master and a Coupling Ring at the same time due to heavy load of system.

5.1.7.2 RSTP

The Rapid Spanning Tree Protocol (RSTP) is an evolution of the Spanning Tree Protocol (STP). It provides faster convergence of spanning tree after a topology change. The system also supports STP and the system will detect the connected device that is running STP or RSTP protocol automatically.

RSTP setting

You can enable/disable RSTP function, and set parameters for each port.

RSTP Setting

RSTP Mode:

Bridge Setting

Priority (0-61440)	<input type="text" value="32768"/>
Max Age Time(6-40)	<input type="text" value="20"/>
Hello Time (1-10)	<input type="text" value="2"/>
Forward Delay Time (4-30)	<input type="text" value="15"/>

Port Setting

Port No.	Path Cost (1-200000000)	Priority (0-240)	P2P	Edge	Non STP
Port.01	<input type="text" value="200000"/>	<input type="text" value="128"/>	<input type="text" value="Auto"/>	<input type="text" value="true"/>	<input type="text" value="false"/>
Port.02	<input type="text" value="200000"/>	<input type="text" value="128"/>	<input type="text" value="Auto"/>	<input type="text" value="true"/>	<input type="text" value="false"/>
Port.03	<input type="text" value="200000"/>	<input type="text" value="128"/>	<input type="text" value="Auto"/>	<input type="text" value="true"/>	<input type="text" value="false"/>
Port.04	<input type="text" value="200000"/>	<input type="text" value="128"/>	<input type="text" value="Auto"/>	<input type="text" value="true"/>	<input type="text" value="false"/>
Port.05	<input type="text" value="200000"/>	<input type="text" value="128"/>	<input type="text" value="Auto"/>	<input type="text" value="true"/>	<input type="text" value="false"/>
Port.06	<input type="text" value="200000"/>	<input type="text" value="128"/>	<input type="text" value="Auto"/>	<input type="text" value="true"/>	<input type="text" value="false"/>
Port.07	<input type="text" value="200000"/>	<input type="text" value="128"/>	<input type="text" value="Auto"/>	<input type="text" value="true"/>	<input type="text" value="false"/>
Port.08	<input type="text" value="200000"/>	<input type="text" value="128"/>	<input type="text" value="Auto"/>	<input type="text" value="true"/>	<input type="text" value="false"/>
Port.09	<input type="text" value="200000"/>	<input type="text" value="128"/>	<input type="text" value="Auto"/>	<input type="text" value="true"/>	<input type="text" value="false"/>
Port.10	<input type="text" value="200000"/>	<input type="text" value="128"/>	<input type="text" value="Auto"/>	<input type="text" value="true"/>	<input type="text" value="false"/>
Port.11	<input type="text" value="200000"/>	<input type="text" value="128"/>	<input type="text" value="Auto"/>	<input type="text" value="true"/>	<input type="text" value="false"/>
Port.12	<input type="text" value="200000"/>	<input type="text" value="128"/>	<input type="text" value="Auto"/>	<input type="text" value="true"/>	<input type="text" value="false"/>
Port.13	<input type="text" value="200000"/>	<input type="text" value="128"/>	<input type="text" value="Auto"/>	<input type="text" value="true"/>	<input type="text" value="false"/>
Port.14	<input type="text" value="200000"/>	<input type="text" value="128"/>	<input type="text" value="Auto"/>	<input type="text" value="true"/>	<input type="text" value="false"/>
Port.15	<input type="text" value="200000"/>	<input type="text" value="128"/>	<input type="text" value="Auto"/>	<input type="text" value="true"/>	<input type="text" value="false"/>
Port.16	<input type="text" value="200000"/>	<input type="text" value="128"/>	<input type="text" value="Auto"/>	<input type="text" value="true"/>	<input type="text" value="false"/>
Port.17	<input type="text" value="200000"/>	<input type="text" value="128"/>	<input type="text" value="Auto"/>	<input type="text" value="true"/>	<input type="text" value="false"/>
Port.18	<input type="text" value="200000"/>	<input type="text" value="128"/>	<input type="text" value="Auto"/>	<input type="text" value="true"/>	<input type="text" value="false"/>

RSTP Setting interface

The following table describes the labels in this screen.

Label	Description
RSTP mode	You must enable or disable RSTP function before configuring the related parameters.
Priority (0-61440)	A value used to identify the root bridge. The bridge with the lowest value with the highest priority and is selected as the root. If the value changes, you must restart the switch. The value must be multiple of 4096 according to the rule of the protocol.



Max Age (6-40)	The number of seconds for a bridge to wait without receiving Spanning-tree Protocol configuration messages before reconfiguration. Enter a value between 6 through 40.
Hello Time (1-10)	The time that controls switch sends out the BPDU (Bridge Protocol Data Unit) packet to check RSTP current status. Enter a value between 1 through 10.
Forwarding Delay Time (4-30)	The number of seconds a port to wait before changing from its learning/listening state to forwarding state. Enter a value between 4 through 30.
Path Cost (1-200000000)	The cost of the path to the other bridge from this transmitting bridge at the specified port. Enter a number 1 through 200000000.
Priority (0-240)	Decide which port should be blocked by setting the priority in LAN. Enter a number 0 through 240. The value of priority must be the multiple of 16
Admin P2P	Some of the rapid state transactions that are possible within RSTP are dependent upon whether the port concerned can only be connected to exactly one other bridge (i.e., It is served by a point-to-point LAN segment), or it can be connected to two or more bridges (i.e., It is served by a shared medium LAN segment). This function allows the P2P status of the link to be manipulated administratively. True means P2P enabled. False means P2P disabled.
Admin Edge	The port directly connected to end stations, and it cannot create bridging loop in the network. To configure the port as an edge port, set the port to " True ".
Admin Non STP	The port includes the STP mathematic calculation. STP algorithm is included for " True " setting, STP algorithm is not included for " False " setting.
Apply	Click " Apply " to activate the configurations.

NOTE: Follow the rule to configure the MAX Age, Hello Time, and Forward Delay Time:

$$2 \times (\text{Forward Delay Time value} - 1) \geq \text{Max Age value} \geq 2 \times (\text{Hello Time value} + 1)$$

RSTP Information

Show RSTP algorithm result at this table.

WWW

RSTP Information

Root Bridge Information

Bridge ID	0080001E94ABCDEF
Root Priority	32768
Root Port	ROOT
Root Path Cost	0
Max Age Time	20
Hello Time	2
Forward Delay Time	15

Port Information

Port	Path Cost	Port Priority	OperP2P	OperEdge	STP Neighbor	State	Role
Port.01	200000	128	True	True	False	Disabled	Disabled
Port.02	200000	128	True	True	False	Disabled	Disabled
Port.03	200000	128	True	True	False	Disabled	Disabled
Port.04	200000	128	True	True	False	Disabled	Disabled
Port.05	200000	128	True	True	False	Disabled	Disabled
Port.06	200000	128	True	True	False	Disabled	Disabled
Port.07	200000	128	True	True	False	Disabled	Disabled
Port.08	200000	128	True	True	False	Disabled	Disabled
Port.09	200000	128	True	True	False	Disabled	Disabled
Port.10	200000	128	True	True	False	Disabled	Disabled
Port.11	200000	128	True	True	False	Disabled	Disabled
Port.12	200000	128	True	True	False	Disabled	Disabled
Port.13	200000	128	True	True	False	Disabled	Disabled
Port.14	200000	128	True	True	False	Disabled	Disabled
Port.15	200000	128	True	True	False	Disabled	Disabled
Port.16	200000	128	True	True	False	Forwarding	Designated

RSTP Information interface

5.1.7.3 MSTP

Multiple Spanning Tree Protocol (MSTP) is a standard protocol base on IEEE 802.1s. The function is that several VLANs can be mapping to a reduced number of spanning tree instances because most networks do not need more than a few logical topologies. It supports load balancing scheme and the CPU is sparer than PVST (Cisco proprietary technology).

MSTP Setting

MSTP Enable	Disable ▾
Force Version	MSTP ▾
Configuration Name	MSTP_SWITCH
Revision Level (0-65535)	0
Priority (0-61440)	32768
Max Age Time (6-40)	20
Hello Time (1-10)	2
Forward Delay Time (4-30)	15
Max Hops (1-40)	20

Priority must be a multiple of 4096.
2*(Forward Delay Time-1) should be greater than or equal to the Max Age.
The Max Age should be greater than or equal to 2*(Hello Time + 1).

MSTP Setting interface

The following table describes the labels in this screen.

Label	Description
MSTP Enable	You must enable or disable MSTP function before configuring the related parameters.
Force Version	The Force Version parameter can be used to force a VLAN Bridge that supports RSTP to operate in an STP-compatible manner.
Configuration Name	The same MST Region must have the same MST configuration name.
Revision Level (0-65535)	The same MST Region must have the same revision level.
Priority (0-61440)	A value used to identify the root bridge. The bridge with the lowest value has the highest priority and is selected as the root. If the value changes, You must reboot the switch. The value must be multiple of 4096 according to the protocol standard rule.
Max Age Time(6-40)	The number of seconds a bridge waits without receiving Spanning-tree Protocol configuration messages before attempting a reconfiguration. Enter a value between 6 through 40.
Hello Time (1-10)	The setting follow the rule below to configure the MAX Age, Hello

	<p>Time, and Forward Delay Time at controlled switch sends out the BPDU packet to check RSTP current status. Enter a value between 1 through 10.</p> <p>$2 \times (\text{Forward Delay Time value} - 1) \geq \text{Max Age value} \geq 2 \times (\text{Hello Time value} + 1)$</p>
Forwarding Delay Time (4-30)	The number of seconds a port waits before changing from its Rapid Spanning-Tree Protocol learning and listening states to the forwarding state. Enter a value between 4 through 30.
Max Hops (1-40)	This parameter is additional to those specified for RSTP. A single value applies to all Spanning Trees within an MST Region (the CIST and all MSTIs) for which the Bridge is the Regional Root.
Apply	Click " Apply " to activate the configurations.

MSTP Port

Port No.	Priority (0-240)	Path Cost (1-200000000, 0:Auto)	Admin P2P	Admin Edge	Admin Non Stp
Port.01 ▲ Port.02 ☰ Port.03 Port.04 Port.05 ▼	128	0	auto ▼	true ▼	false ▼

priority must be a multiple of 16

Apply

Port Information

Port	Priority	Path Cost		P2P		Edge		Admin Non Stp
		Admin	Oper	Admin	Oper	Admin	Oper	

MSTP Port interface

Label	Description
Port No.	Selecting the port that you want to configure.
Priority (0-240)	Decide which port should be blocked by priority in LAN. Enter a number 0 through 240. The value of priority must be the multiple of 16
Path Cost (1-200000000)	The cost of the path to the other bridge from this transmitting bridge at the specified port. Enter a number 1 through

	200000000.
Admin P2P	Some of the rapid state transactions that are possible within RSTP are dependent upon whether the port concerned can only be connected to exactly one other bridge (i.e. It is served by a point-to-point LAN segment), or it can be connected to two or more bridges (i.e. It is served by a shared medium LAN segment). This function allows the P2P status of the link to be manipulated administratively. True means P2P enabling. False means P2P disabling.
Admin Edge	Label
Admin Non STP	Label
Apply	Click " Apply " to activate the configurations.

MSTP Instance

Instance	State	VLANs	Priority (0-61440)
1 <input type="button" value="v"/>	Enable <input type="button" value="v"/>	1-4094	32768

Priority must be a multiple of 4096.

Instance Information

Instance	VLANs	Priority	Regional Root Bridge ID	Path Cost	Root Port

MSTP Instance interface

Label	Description
Instance	Set the instance from 1 to 15
State	Enable or disable the instance
VLANs	Set which VLAN will belong which instance
Proprietary (0-61440)	A value used to identify the root bridge. The bridge with the lowest value has the highest priority and is selected as the root. If the value changes, You must reboot the switch. The value must be multiple of 4096 according to the protocol standard rule.
Apply	Click " Apply " to activate the configurations.

MSTP Instance Port

Instance:

Port	Priority (0-240)	Path Cost (1-200000000, 0: Auto)
<input type="text" value="Port.01"/> <input type="text" value="Port.02"/> <input type="text" value="Port.03"/> <input type="text" value="Port.04"/> <input type="text" value="Port.05"/>	<input type="text" value="128"/>	<input type="text" value="0"/>

Priority must be a multiple of 16

Instance Port Information

Port No.	Priority	Path Cost		State	Role
		Admin	Oper		

MSTP Instance Port interface

Label	Description
Instance	Set the instance's information except CIST
Port	Selecting the port that you want to configure.
Priority (0-240)	Decide which port should be blocked by priority in LAN. Enter a number 0 through 240. The value of priority must be the multiple of 16
Path Cost (1-200000000)	The cost of the path to the other bridge from this transmitting bridge at the specified port. Enter a number 1 through 200000000.
Apply	Click " Apply " to set the configurations.

5.1.8 VLAN

A Virtual LAN (VLAN) is a logical network grouping that limits the broadcast domain, which allows you to isolate network traffic. Only the members of the same VLAN will receive the traffic from the other members. Basically, to create a VLAN from a switch is logically equivalent of separating a group of network devices. However, all the network devices are still plugged into the same switch physically.

This managed switch supports port-based and 802.1Q (tagged-based) VLAN. The default configuration of VLAN operation mode is at "**802.1Q**".

5.1.8.1 VLAN Setting

Tagged-based VLAN is an IEEE 802.1Q specification standard, and it is possible to create a VLAN across devices from different switch vendors. IEEE 802.1Q VLAN uses a technique to insert a "tag" into the Ethernet frames. Tag contains a VLAN Identifier (VID) that indicates the VLAN numbers.

You can create Tag-based VLAN, and enable or disable GVRP protocol. There are 256 VLAN groups available. Enable 802.1Q VLAN, all ports on the switch belong to default VLAN, VID is 1. The default VLAN cannot be deleted.

GVRP allows automatic VLAN configuration between the switch and nodes. If the switch is connected to a device with GVRP enabled, you can send a GVRP request by using the VID of a VLAN defined on the switch; the switch will automatically add that device to the existing VLAN.

VLAN Setting

VLAN Operation Mode : 802.1Q

GVRP Mode : Disable

Management Vlan ID : 0

VLAN Configuration

Port No.	Link Type	Untagged VID	Tagged VIDs
Port.01	Access <input type="button" value="v"/>	1	
Port.02	Access <input type="button" value="v"/>	1	
Port.03	Access <input type="button" value="v"/>	1	
Port.04	Access <input type="button" value="v"/>	1	
Port.05	Access <input type="button" value="v"/>	1	
Port.06	Access <input type="button" value="v"/>	1	
Port.07	Access <input type="button" value="v"/>	1	
Port.08	Access <input type="button" value="v"/>	1	
Port.09	Access <input type="button" value="v"/>	1	
Port.10	Access <input type="button" value="v"/>	1	
Port.11	Access <input type="button" value="v"/>	1	
Port.12	Access <input type="button" value="v"/>	1	
Port.13	Access <input type="button" value="v"/>	1	
Port.14	Access <input type="button" value="v"/>	1	
Port.15	Access <input type="button" value="v"/>	1	
Port.16	Access <input type="button" value="v"/>	1	

Note: Use the comma to separate the multiple tagged VIDs.
E.g., 2-4,6 means joining the Tagged VLAN 2, 3, 4 and 6.

VLAN Configuration – 802.1Q interface

The following table describes the labels in this screen.

Label	Description
VLAN Operation Mode	Configure VLAN Operation Mode: disable, Port Base,802.1Q
GVRP Mode	Enable/Disable GVRP function.

Management VLAN ID	Management VLAN provide network administrator a secured VLAN to management Switch. Only the devices in the management VLAN can access the switch.
Link type	There are 3 types of link type: Access Link: single switch only, allows you to group ports by setting the same VID. Trunk Link: extended application of Access Link , allows you to group ports by setting the same VID with 2 or more switches. Hybrid Link: Both Access Link and Trunk Link are available. Hybrid(QinQ) Link: enable QinQ mode , allow you to insert one more VLAN tag in a original VLAN frame.
Untagged VID	Set the port default VLAN ID for untagged devices that connect to the port. The range is 1 to 4094.
Tagged VIDs	Set the tagged VIDs to carry different VLAN frames to other switch.
Apply	Click " Apply " to activate the configurations.

5.1.8.2 VLAN Setting – Port Based

Traffic is forwarded to the member ports of the same vlan group. vlan port based startup, set in the same group of the port, can be a normal transmission packet, without restricting the types of packets.

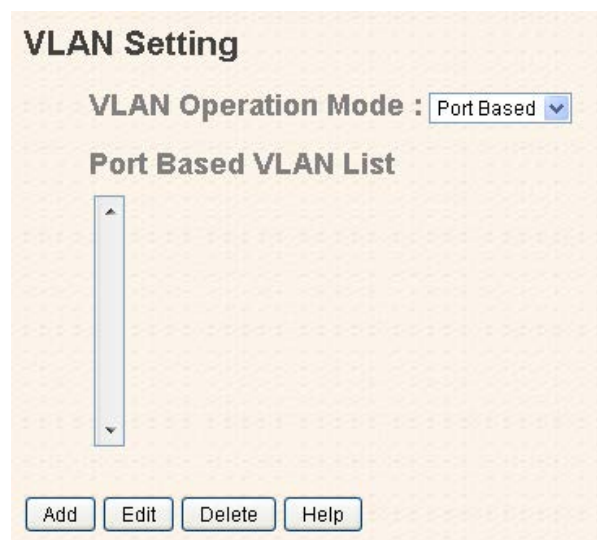

VLAN Configuration – Port Base interface-1

The following table describes the labels in this screen.

Label	Description
Add	Click “ add ” to enter VLAN add interface.
Edit	Edit exist VLAN
Delete	Delete exist VLAN
Help	Show help file.

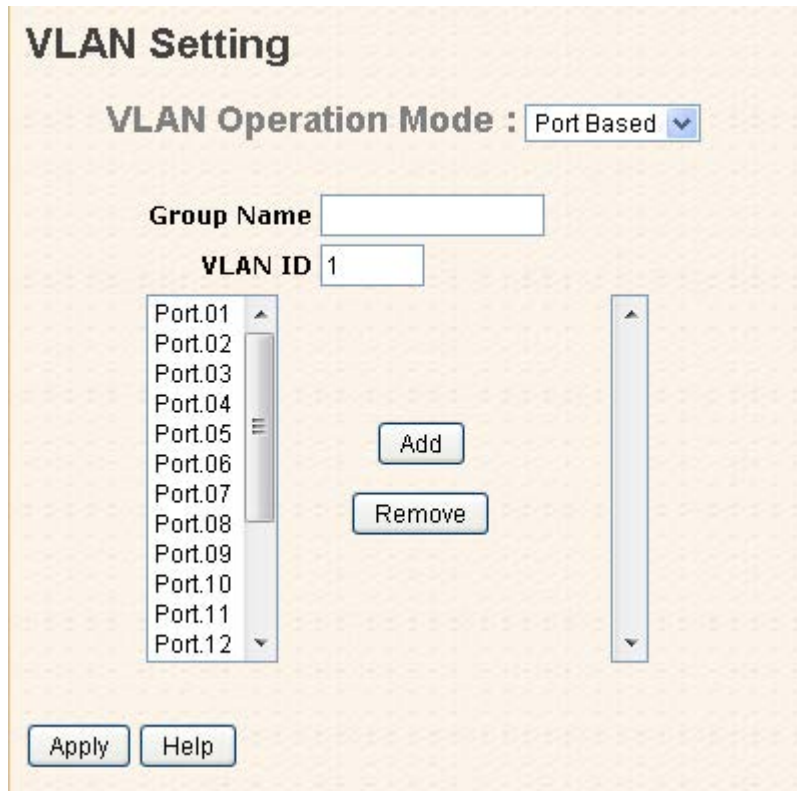

VLAN Setting

VLAN Operation Mode : Port Based

Group Name

VLAN ID

Port.01
Port.02
Port.03
Port.04
Port.05
Port.06
Port.07
Port.08
Port.09
Port.10
Port.11
Port.12

Add

Remove

Apply Help

VLAN Configuration – Port Base interface-2

The following table describes the labels in this screen.

Label	Description
Group Name	VLAN name.
VLAN ID	Specify the VLAN ID
Add	Select port to join the VLAN group.
Remove	Remove port of the VLAN group
Apply	Click “ Apply ” to activate the configurations.
Help	Show help file.

5.1.9 SNMP

Simple Network Management Protocol (SNMP) is the protocol developed to manage nodes (servers, workstations, routers, switches and hubs etc.) on an IP network. SNMP enables network administrators to manage network performance, find and solve network problems, and plan for network growth. Network management systems learn of problems by receiving traps or change notices from network devices implementing SNMP.

5.1.9.1 SNMP – Agent Setting

You can set SNMP agent related information by Agent Setting Function.



SNMP - Agent Setting

SNMP Agent Version
 SNMPV1/V2c

SNMP V1/V2c Community

Community String	Privilege
public	Read Only
private	Read and Write
	Read Only
	Read Only

SNMPv3 User

User Name	<input type="text"/>
Auth Password	<input type="text"/>
Privacy Password	<input type="text"/>

Current SNMPv3 User Profile

User Name	Auth. Password	Priv. Password

SNMP Agent Setting interface

The following table describes the labels in this screen.

Label	Description
SNMP agent Version	Three SNMP versions are supported such as SNMP V1/SNMP V2c, and SNMP V3. SNMP V1/SNMP V2c agent use a community string match for authentication, that means SNMP

	<p>servers access objects with read-only or read/write permissions with the community default string public/private. SNMP V3 requires an authentication level of MD5 or DES to encrypt data to enhance data security.</p>
SNMP V1/V2c Community	<p>SNMP Community should be set for SNMP V1/V2c. Four sets of "Community String/Privilege" are supported. Each Community String is maximum 32 characters. Keep empty to remove this Community string.</p>
SNMPv3User	<p>If SNMP V3 agent is selected, the SNMPv3 you profiled should be set for authentication. The Username is necessary. The Auth Password is encrypted by MD5 and the Privacy Password which is encrypted by DES. There are maximum 8 sets of SNMPv3 User and maximum 16 characters in username, and password.</p> <p>When SNMP V3 agent is selected, you can:</p> <ol style="list-style-type: none"> 1. Input SNMPv3 username only. 2. Input SNMPv3 username and Auth Password. 3. Input SNMPv3 username, Auth Password and Privacy Password, which can be different with Auth Password. <p>To remove a current user profile:</p> <ol style="list-style-type: none"> 1. Input SNMPv3 user name you want to remove. 2. Click "Remove" button
Current SNMPv3 User Profile	<p>Show all SNMPv3 user profiles.</p>
Apply	<p>Click "Apply" to activate the configurations.</p>
Help	<p>Show help file.</p>

5.1.9.2 SNMP – Trap Setting

A trap manager is a management station that receives traps, the system alerts generated by the switch. If no trap manager is defined, no traps will issue. Create a trap manager by entering the IP address of the station and a community string. To define management stations as trap manager and enter SNMP community strings and selects the SNMP version.

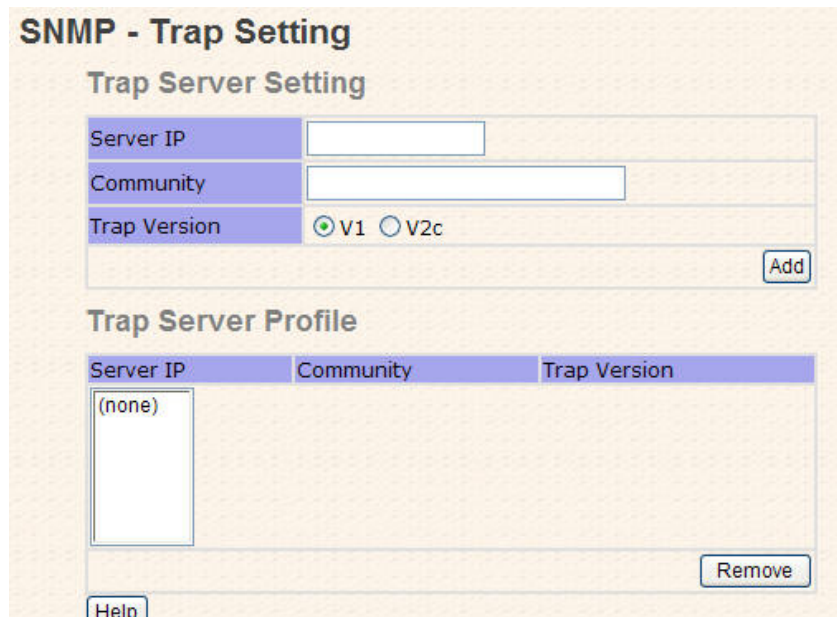

The image shows the 'SNMP - Trap Setting' web interface. It is divided into two main sections: 'Trap Server Setting' and 'Trap Server Profile'.
 In the 'Trap Server Setting' section, there are three input fields: 'Server IP', 'Community', and 'Trap Version'. The 'Trap Version' field has two radio buttons, 'V1' (which is selected) and 'V2c'. An 'Add' button is located at the bottom right of this section.
 The 'Trap Server Profile' section contains a table with three columns: 'Server IP', 'Community', and 'Trap Version'. The table currently has one row with '(none)' in the 'Server IP' column. A 'Remove' button is at the bottom right, and a 'Help' button is at the bottom left.

SNMP Trap Setting interface

The following table describes the labels in this screen.

Label	Description
Server IP	The server IP address to receive Trap
Community	Community for authentication
Trap Version	Trap Version supports V1 and V2c.
Add	Add trap server profile.
Remove	Remove trap server profile.
Help	Show help file.

5.1.10 Traffic Prioritization

Traffic Prioritization includes 3 modes: port base, 802.1p/COS, and TOS/DSCP. By traffic prioritization function, you can classify the traffic into four classes for differential network application. IES-3160 support 4 priority queues.

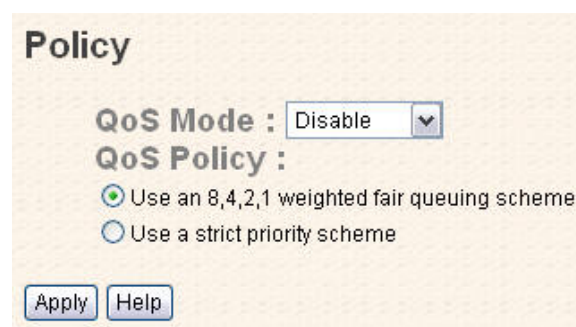

The image shows the 'Policy' web interface. It features a 'QoS Mode' dropdown menu currently set to 'Disable'. Below it is the 'QoS Policy' section with two radio buttons: 'Use an 8,4,2,1 weighted fair queuing scheme' (which is selected) and 'Use a strict priority scheme'. At the bottom, there are 'Apply' and 'Help' buttons.

Policy Setting interface

Label	Description
QoS Mode	<ul style="list-style-type: none">■ Port-base: the output priority is determined by ingress port.■ COS only: the output priority is determined by COS only.■ TOS only: the output priority is determined by TOS only.■ COS first: the output priority is determined by COS and TOS, but COS first.■ TOS first: the output priority is determined by COS and TOS, but TOS first.
QoS policy	<ul style="list-style-type: none">■ Using the 8,4,2,1 weight fair queue scheme: the output queues will follow 8:4:2:1 ratio to transmit packets from the highest to lowest queue. For example: 8 high queue packets, 4 middle queue packets, 2 low queue packets, and the one lowest queue packets are transmitted in one turn.■ Use the strict priority scheme: always the packets in higher queue will be transmitted first until higher queue is empty.
Help	Show help file.
Apply	Click " Apply " to activate the configurations.

Port-based Priority

Port No.	Priority
Port.01	Lowest ▾
Port.02	Lowest ▾
Port.03	Lowest ▾
Port.04	Lowest ▾
Port.05	Lowest ▾
Port.06	Lowest ▾
Port.07	Lowest ▾
Port.08	Lowest ▾
Port.09	Lowest ▾
Port.10	Lowest ▾
Port.11	Lowest ▾
Port.12	Lowest ▾
Port.13	Lowest ▾
Port.14	Lowest ▾
Port.15	Lowest ▾
Port.16	Lowest ▾

Port-based Priority interface

Label	Description
Port base Priority	Assign Port with a priority queue. 4 priority queues can be assigned: High, Middle, Low, and Lowest.
Help	Show help file.
Apply	Click " Apply " to activate the configurations.

COS/802.1p

COS	Priority
0	Low
1	Lowest
2	Lowest
3	Low
4	Middle
5	Middle
6	High
7	High

COS Port Default

Port No.	COS
Port.01	0
Port.02	0
Port.03	0
Port.04	0
Port.05	0
Port.06	0
Port.07	0
Port.08	0
Port.09	0
Port.10	0
Port.11	0
Port.12	0
Port.13	0
Port.14	0
Port.15	0
Port.16	0

COS/802.1p interface

Label	Description
COS/802.1p	COS (Class Of Service) is well known as 802.1p. It describes that the output priority of a packet is determined by user priority field in 802.1Q VLAN tag. The priority value is supported 0to7.COS value map to 4 priority queues: High, Middle, Low, and Lowest.
COS Port Default	When an ingress packet has not VLAN tag, a default priority value is considered and determined by ingress port.
Help	Show help file.
Apply	Click " Apply " to activate the configurations.

TOS/DSCP

DSCP	0	1	2	3	4	5	6	7
Priority	Lowest ▾	Lowest ▾	Lowest ▾	Lowest ▾	Lowest ▾	Lowest ▾	Lowest ▾	Lowest ▾
DSCP	8	9	10	11	12	13	14	15
Priority	Lowest ▾	Lowest ▾	Lowest ▾	Lowest ▾	Lowest ▾	Lowest ▾	Lowest ▾	Lowest ▾
DSCP	16	17	18	19	20	21	22	23
Priority	Low ▾	Low ▾	Low ▾	Low ▾	Low ▾	Low ▾	Low ▾	Low ▾
DSCP	24	25	26	27	28	29	30	31
Priority	Low ▾	Low ▾	Low ▾	Low ▾	Low ▾	Low ▾	Low ▾	Low ▾
DSCP	32	33	34	35	36	37	38	39
Priority	Middle ▾	Middle ▾	Middle ▾	Middle ▾	Middle ▾	Middle ▾	Middle ▾	Middle ▾
DSCP	40	41	42	43	44	45	46	47
Priority	Middle ▾	Middle ▾	Middle ▾	Middle ▾	Middle ▾	Middle ▾	Middle ▾	Middle ▾
DSCP	48	49	50	51	52	53	54	55
Priority	High ▾	High ▾	High ▾	High ▾	High ▾	High ▾	High ▾	High ▾
DSCP	56	57	58	59	60	61	62	63
Priority	High ▾	High ▾	High ▾	High ▾	High ▾	High ▾	High ▾	High ▾

TOS/DSCP interface

Label	Description
TOS/DSCP	TOS (Type of Service) is a field in IP header of a packet. This TOS field is also used by Differentiated Services and is called the Differentiated Services Code Point (DSCP). The output priority of a packet can be determined by this field and the priority value is supported 0 to 63. DSCP value map to 4 priority queues: High, Middle, Low, and Lowest.
Apply	Click " Apply " to activate the configurations.
Help	Show help file.

5.1.11 Multicast

5.1.11.1 IGMP Snooping

Internet Group Management Protocol (IGMP) is used by IP hosts to register their dynamic multicast group membership. IGMP has 3 versions, IGMP v1, v2 and v3. Please refer to RFC 1112, 2236 and 3376. IGMP Snooping improves the performance of networks that carry multicast traffic. It provides the ability to prune multicast traffic so that it travels only to those end destinations that require that traffic and reduces the amount of traffic on the Ethernet LAN.

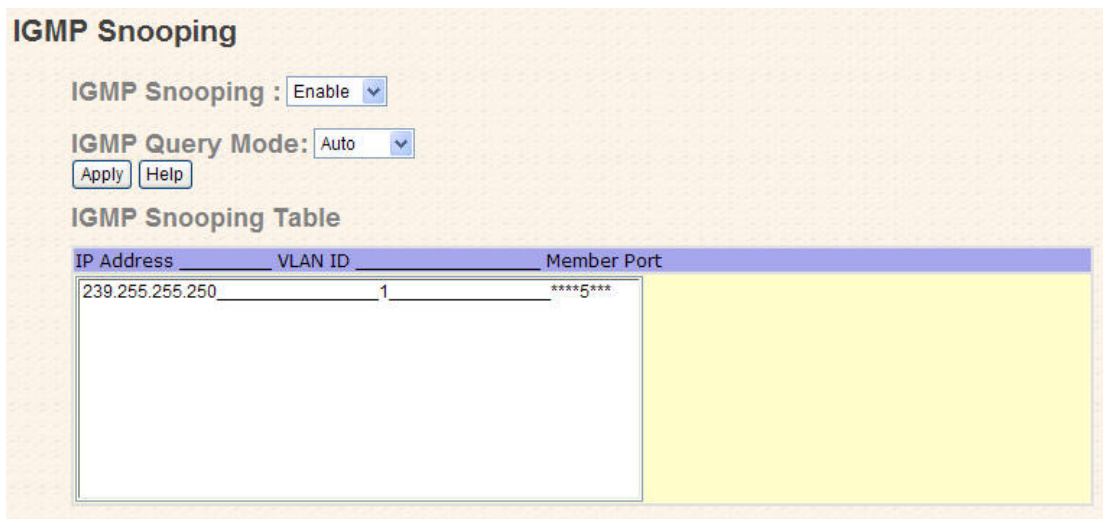

IGMP Snooping

IGMP Snooping : ▾

IGMP Query Mode: ▾

IGMP Snooping Table

IP Address	VLAN ID	Member Port
239.255.255.250	1	*****5*****

IGMP Snooping interface

The following table describes the labels in this screen.

Label	Description
IGMP Snooping	Enable/Disable IGMP snooping.
IGMP Query Mode	Switch will be IGMP querier or not. There should exist one and the only one IGMP querier in an IGMP application. The "Auto" mode means that the querier is the one with lower IP address.
IGMP Snooping Table	Show current IP multicast list
Apply	Click " Apply " to activate the configurations.
Help	Show help file.

5.1.11.2 MVR

MVR

MVR Mode: ▾

MVR VLAN:

Port	Type	Immediate Leave
Port.01	<input type="text" value="Inactive"/> ▾	<input type="checkbox"/>
Port.02	<input type="text" value="Inactive"/> ▾	<input type="checkbox"/>
Port.03	<input type="text" value="Inactive"/> ▾	<input type="checkbox"/>
Port.04	<input type="text" value="Inactive"/> ▾	<input type="checkbox"/>
Port.05	<input type="text" value="Inactive"/> ▾	<input type="checkbox"/>
Port.06	<input type="text" value="Inactive"/> ▾	<input type="checkbox"/>
Port.07	<input type="text" value="Inactive"/> ▾	<input type="checkbox"/>
Port.08	<input type="text" value="Inactive"/> ▾	<input type="checkbox"/>
Port.09	<input type="text" value="Inactive"/> ▾	<input type="checkbox"/>
Port.10	<input type="text" value="Inactive"/> ▾	<input type="checkbox"/>
Port.11	<input type="text" value="Inactive"/> ▾	<input type="checkbox"/>
Port.12	<input type="text" value="Inactive"/> ▾	<input type="checkbox"/>
Port.13	<input type="text" value="Inactive"/> ▾	<input type="checkbox"/>
Port.14	<input type="text" value="Inactive"/> ▾	<input type="checkbox"/>
Port.15	<input type="text" value="Inactive"/> ▾	<input type="checkbox"/>
Port.16	<input type="text" value="Inactive"/> ▾	<input type="checkbox"/>

MVR interface

5.1.11.3 Multicast Filter

Multicast filtering is the system by which end stations only receive multicast traffic if they register to join specific multicast groups. With multicast filtering, network devices only forward multicast traffic to the ports that are connected to registered end stations.

Multicast Filtering

IP Address

Port.01 Port.02 Port.03 Port.04
 Port.05 Port.06 Port.07 Port.08

Member Ports

Port.09 Port.10 Port.11 Port.12
 Port.13 Port.14 Port.15 Port.16

Multicast Filtering List

IP Address	Member Ports

Multicast Filtering interface

The following table describes the labels in this screen.

Label	Description
IP Address	Assign a multicast group IP address in the range of 224.0.0.0 ~ 239.255.255.255
Member Ports	Tick the check box beside the port number to include them as the member ports in the specific multicast group IP address.
Add	Show current IP multicast list
Delete	Delete an entry from table
Help	Show help file.

5.1.12 Security

Five useful functions can enhance security of switch: IP Security, Port Security, MAC Blacklist, and MAC address Aging and 802.1x protocol.

5.1.12.1 IP Security

IP security can enable/disable remote management from WEB or Telnet or SNMP. Additionally, IP security can restrict remote management to some specific IP addresses. Only these secure IP addresses can manage this switch remotely.



IP Security interface

The following table describes the labels in this screen.

Label	Description
IP security MODE	Enable/Disable the IP security function.
Enable WEB	Mark the blank to enable WEB Management.

Management	
Enable Telnet Management	Mark the blank to enable Telnet Management.
Enable SNMP Management	Mark the blank to enable MPSN Management.
Apply	Click " Apply " to activate the configurations.
Help	Show help file.

5.1.12.2 Port Security

Port security is to add static MAC addresses to hardware forwarding database. If port security is enabled at **Port Control** page, only the frames with MAC addresses in this list will be forwarded, otherwise will be discarded.

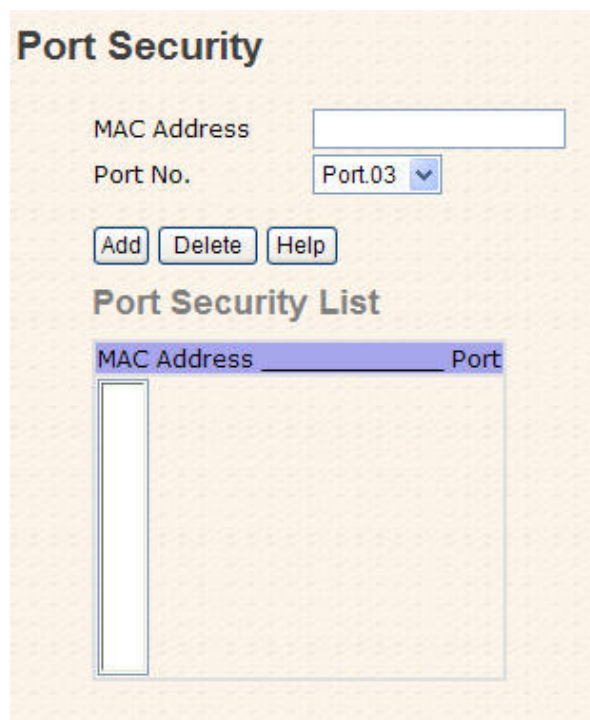

Port Security interface

The following table describes the labels in this screen.

Label	Description
MAC Address	Input MAC Address to a specific port.
Port NO.	Select port of switch.
Add	Add an entry of MAC and port information.
Delete	Delete the entry.
Help	Show help file.

5.1.12.3 MAC Blacklist

MAC Blacklist can eliminate the traffic forwarding to specific MAC addresses in list. Any frames forwarding to MAC addresses in this list will be discarded. Thus the target device will never receive any frame.

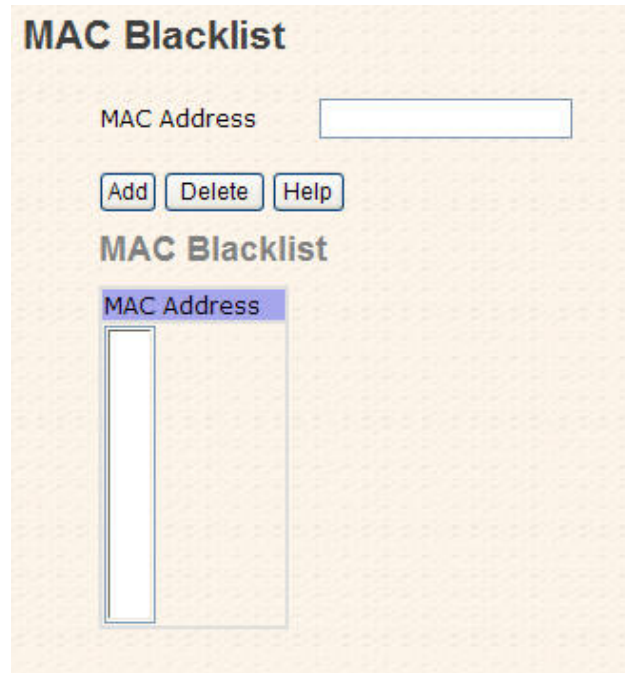

The screenshot shows a web interface for managing a MAC blacklist. At the top, there is a title 'MAC Blacklist'. Below the title is a text input field labeled 'MAC Address'. Underneath the input field are three buttons: 'Add', 'Delete', and 'Help'. Below the buttons is another title 'MAC Blacklist' and a table with one column header 'MAC Address'.

MAC Blacklist interface

The following table describes the labels in this screen.

Label	Description
MAC Address	Input MAC Address to add to MAC Blacklist.
Port NO.	Select port of switch.
Add	Add an entry to Blacklist table.
Delete	Delete the entry.
Help	Show help file.

5.1.12.4 802.1x

802.1x - Radius Server

802.1x makes the use of the physical access characteristics of IEEE802 LAN infrastructures in order to provide a authenticated and authorized devices attached to a LAN port. Please refer to IEEE 802.1X - Port Based Network Access Control.

802.1x - Radius Server

Radius Server Setting

802.1x Protocol	Disable ▾
Radius Server IP	192.168.16.3
Server Port	1812
Accounting Port	1813
Shared Key	12345678
NAS, Identifier	NAS_L2_SWITCH

Advanced Setting

Quiet Period	60
TX Period	30
Supplicant Timeout	30
Server Timeout	30
Max Requests	2
Re-Auth Period	3600

802.1x Radius Server interface

The following table describes the labels in this screen.

Label	Description
Radius Server Setting	
Radius Server IP	The IP address of the authentication server.
Server port	Set the UDP port number used by the authentication server to authenticate.
Account port	Set the UDP destination port for accounting requests to the specified Radius Server.
Shared Key	A key shared between this switch and authentication server.
NAS, Identifier	A string used to identify this switch.
Advanced Setting	
Quiet Period	Set the time interval between authentication failure and the start of a new authentication attempt.
Tx Period	Set the time that the switch can wait for response to an EAP request/identity frame from the client before resending the request.

Supplicant Timeout	Set the period of time the switch waits for a supplicant response to an EAP request.
Server Timeout	Set the period of time the switch waits for a Radius server response to an authentication request.
Max Requests	Set the maximum number of times to retry sending packets to the supplicant.
Re-Auth Period	Set the period of time after which clients connected must be re-authenticated.
Apply	Click " Apply " to activate the configurations.
Help	Show help file.

802.1x-Port Authorized Mode

Set the 802.1x authorized mode of each port.

802.1x - Port Authorize Mode

Port No.	Port Authorize Mode
Port.01	Accept <input type="button" value="v"/>
Port.02	Accept <input type="button" value="v"/>
Port.03	Accept <input type="button" value="v"/>
Port.04	Accept <input type="button" value="v"/>
Port.05	Accept <input type="button" value="v"/>
Port.06	Accept <input type="button" value="v"/>
Port.07	Accept <input type="button" value="v"/>
Port.08	Accept <input type="button" value="v"/>
Port.09	Accept <input type="button" value="v"/>
Port.10	Accept <input type="button" value="v"/>
Port.11	Accept <input type="button" value="v"/>
Port.12	Accept <input type="button" value="v"/>
Port.13	Accept <input type="button" value="v"/>
Port.14	Accept <input type="button" value="v"/>
Port.15	Accept <input type="button" value="v"/>
Port.16	Accept <input type="button" value="v"/>

802.1x Port Authorize interface

The following table describes the labels in this screen.

Label	Description
Port Authorized Mode	<ul style="list-style-type: none"> ■ Reject: force this port to be unauthorized. ■ Accept: force this port to be authorized. ■ Authorize: the state of this port was determined by the outcome of the 802.1x authentication. ■ Disable: this port will not participate in 802.1x.
Apply	Click " Apply " to activate the configurations.
Help	Show help file.

802.1x-Port Authorized State

Show 802.1x port authorized state.

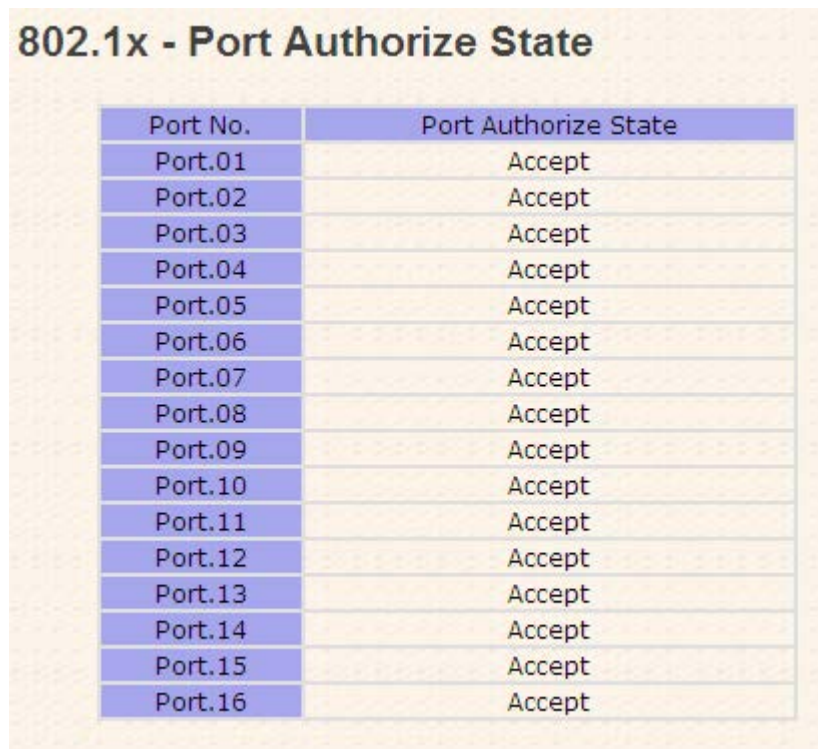

802.1x - Port Authorize State

Port No.	Port Authorize State
Port.01	Accept
Port.02	Accept
Port.03	Accept
Port.04	Accept
Port.05	Accept
Port.06	Accept
Port.07	Accept
Port.08	Accept
Port.09	Accept
Port.10	Accept
Port.11	Accept
Port.12	Accept
Port.13	Accept
Port.14	Accept
Port.15	Accept
Port.16	Accept

802.1x Port Authorize State interface

5.1.13 Warning

Warning function is very important for managing switch. You can manage switch by SYSLOG, E-MAIL, and Fault Relay. It helps you to monitor the switch status on remote site. When events occurred, the warning message will send to your appointed server, E-MAIL, or relay fault to switch panel.

5.1.13.1 Fault Alarm

When any selected fault event is happened, the Fault LED in switch panel will light up and the electric relay will signal at the same time.

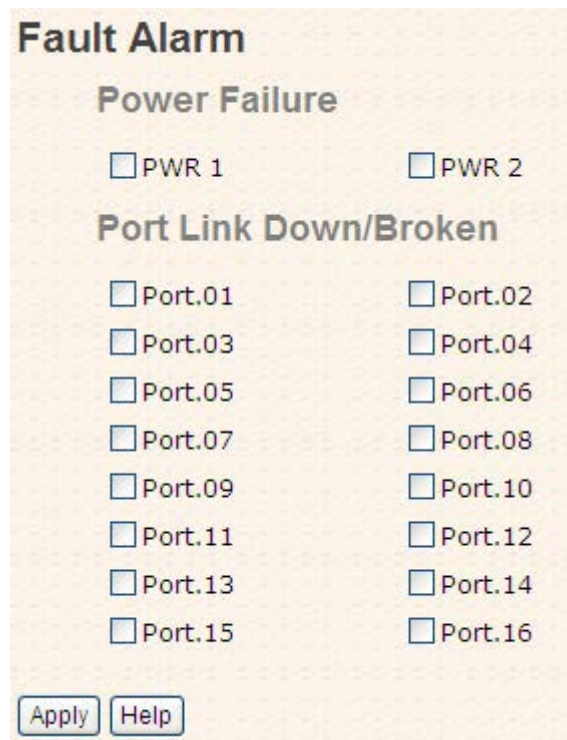

Fault Alarm interface

The following table describes the labels in this screen.

Label	Description
Power Failure	Mark the blank of PWR 1 or PWR 2 to monitor.
Port Link Down/Broken	Mark the blank of port 1 to port 16 to monitor.
Apply	Click " Apply " to activate the configurations.
Help	Show help file.

5.1.13.2 System Alarm

System alarm support two warning mode: 1. SYSLOG. 2. E-MAIL. You can monitor switch through selected system events.

System Warning – SYSLOG Setting

The SYSLOG is a protocol to transmit event notification messages across networks. Please refer to RFC 3164 - The BSD SYSLOG Protocol

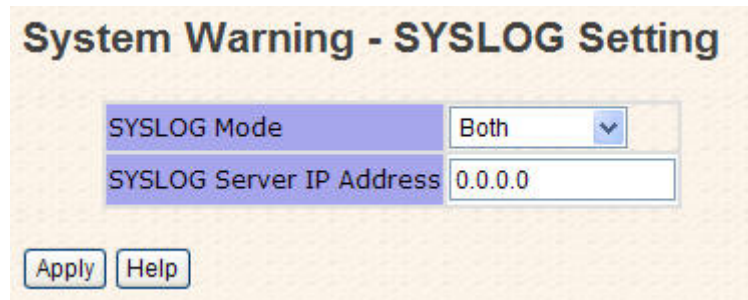

System Warning – SYSLOG Setting interface

The following table describes the labels in this screen.

Label	Description
SYSLOG Mode	<ul style="list-style-type: none"> ■ Disable: disable SYSLOG. ■ Client Only: log to local system. ■ Server Only: log to a remote SYSLOG server. ■ Both: log to both of local and remote server.
SYSLOG Server IP Address	The remote SYSLOG Server IP address.
Apply	Click " Apply " to activate the configurations.
Help	Show help file.

System Warning – SMTP Setting

The SMTP is Short for Simple Mail Transfer Protocol. It is a protocol for e-mail transmission across the Internet. Please refer to RFC 821 - Simple Mail Transfer Protocol.

System Warning - SMTP Setting

E-mail Alert :

SMTP Configuration

SMTP Server IP Address	<input type="text"/>
Sender E-mail Address	<input type="text"/>
Mail Subject	<input type="text"/>
<input type="checkbox"/> Authentication	
Recipient E-mail Address 1	<input type="text"/>
Recipient E-mail Address 2	<input type="text"/>
Recipient E-mail Address 3	<input type="text"/>
Recipient E-mail Address 4	<input type="text"/>
Recipient E-mail Address 5	<input type="text"/>
Recipient E-mail Address 6	<input type="text"/>

System Warning – SMTP Setting interface

The following table describes the labels in this screen.

Label	Description
E-mail Alarm	Enable/Disable transmission system warning events by e-mail.
Sender E-mail Address	The SMTP server IP address
Mail Subject	The Subject of the mail
Authentication	<ul style="list-style-type: none"> ■ Username: the authentication username. ■ Password: the authentication password. ■ Confirm Password: re-enter password.
Recipient E-mail Address	The recipient's E-mail address. It supports 6 recipients for a mail.
Apply	Click " Apply " to activate the configurations.
Help	Show help file.

System Warning – Event Selection

SYSLOG and SMTP are the two warning methods that supported by the system. Check the corresponding box to enable system event warning method you wish to choose. Please note that the checkbox can not be checked when SYSLOG or SMTP is disabled.

System Warning - Event Selection

System Event

Event	SYSLOG	SMTP
System Cold Start	<input type="checkbox"/>	<input checked="" type="checkbox"/>
Power Status	<input type="checkbox"/>	<input type="checkbox"/>
SNMP Authentication Failure	<input checked="" type="checkbox"/>	<input type="checkbox"/>
O-Ring Topology Change	<input type="checkbox"/>	<input checked="" type="checkbox"/>

Port Event

Port No.	SYSLOG	SMTP
Port.01	Disable <input type="button" value="v"/>	Disable <input type="button" value="v"/>
Port.02	Disable <input type="button" value="v"/>	Disable <input type="button" value="v"/>
Port.03	Disable <input type="button" value="v"/>	Disable <input type="button" value="v"/>
Port.04	Disable <input type="button" value="v"/>	Disable <input type="button" value="v"/>
Port.05	Disable <input type="button" value="v"/>	Disable <input type="button" value="v"/>
Port.06	Disable <input type="button" value="v"/>	Disable <input type="button" value="v"/>
Port.07	Disable <input type="button" value="v"/>	Disable <input type="button" value="v"/>
Port.08	Disable <input type="button" value="v"/>	Disable <input type="button" value="v"/>
Port.09	Disable <input type="button" value="v"/>	Disable <input type="button" value="v"/>
Port.10	Disable <input type="button" value="v"/>	Disable <input type="button" value="v"/>
Port.11	Disable <input type="button" value="v"/>	Disable <input type="button" value="v"/>
Port.12	Disable <input type="button" value="v"/>	Disable <input type="button" value="v"/>
Port.13	Disable <input type="button" value="v"/>	Disable <input type="button" value="v"/>
Port.14	Disable <input type="button" value="v"/>	Disable <input type="button" value="v"/>
Port.15	Disable <input type="button" value="v"/>	Disable <input type="button" value="v"/>
Port.16	Disable <input type="button" value="v"/>	Disable <input type="button" value="v"/>

System Warning – Event Selection interface

The following table describes the labels in this screen.

Label	Description
System Event	
System Cold Start	Alert when system restart
Power Status	Alert when a power up or down
SNMP Authentication Failure	Alert when SNMP authentication failure.
O-Ring Topology Change	Alert when O-Ring topology changes.
Port Event SYSLOG / SMTP event	<ul style="list-style-type: none">■ Disable■ Link Up■ Link Down■ Link Up & Link Down
Apply	Click " Apply " to activate the configurations.
Help	Show help file.

5.1.14 Monitor and Diag

5.1.14.1 MAC Address Table

Refer to IEEE 802.1 D Sections 7.9. The MAC Address Table, that is Filtering Database, supports queries by the Forwarding Process, as to whether a frame received by a given port with a given destination MAC address is to be forwarded through a given potential transmission port.

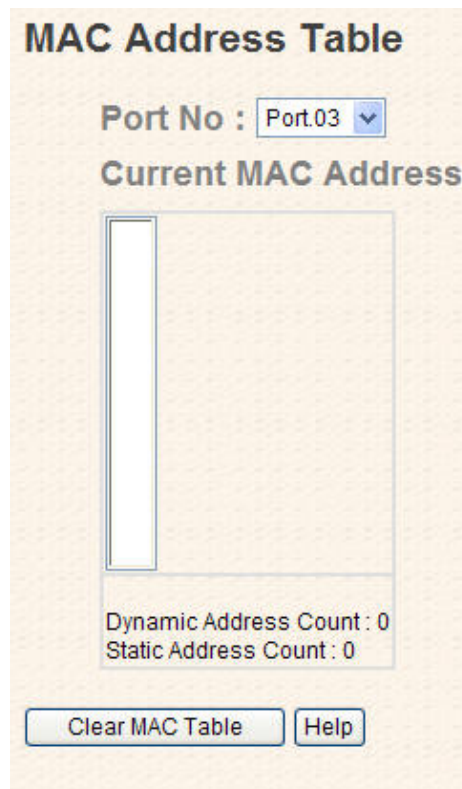

MAC Address Table interface

The following table describes the labels in this screen.

Label	Description
Port NO. :	Show all MAC addresses mapping to a selected port in table.
Clear MAC Table	Clear all MAC addresses in table
Help	Show help file.

5.1.14.2 MAC Address Aging

You can set MAC Address aging timer, as time expired, the unused MAC will be cleared from MAC table. IES-3160 also support Auto Flush MAC Address Table When ports Link Down.



MAC Address Aging interface

The following table describes the labels in this screen.

Label	Description
MAC Address Table Aging Time	Set the aging time for MAC table. The value is between 0 and 3825. Default setting is 300 secs.
Auto Flush MAC Address Table When ports Link Down	Enable this function,
Apply	Click " Apply " to activate the configurations.
Help	Show help file.

5.1.14.3 Port Statistics

Port statistics show several statistics counters for all ports

Port Statistics

Port	Type	Link	State	TX Good Packet	TX Bad Packet	RX Good Packet	RX Bad Packet	TX Abort Packet	Packet Collision
Port.01	100TX	Down	Enable	0	0	0	0	0	0
Port.02	100TX	Down	Enable	0	0	0	0	0	0
Port.03	100TX	Up	Enable	6528	0	10239	0	0	0
Port.04	100TX	Down	Enable	0	0	0	0	0	0
Port.05	100TX	Down	Enable	0	0	0	0	0	0
Port.06	100TX	Down	Enable	0	0	0	0	0	0
Port.07	100TX	Down	Enable	0	0	0	0	0	0
Port.08	100TX	Down	Enable	0	0	0	0	0	0
Port.09	100TX	Down	Enable	0	0	0	0	0	0
Port.10	100TX	Down	Enable	0	0	0	0	0	0
Port.11	100TX	Down	Enable	0	0	0	0	0	0
Port.12	100TX	Down	Enable	0	0	0	0	0	0
Port.13	100TX	Down	Enable	0	0	0	0	0	0
Port.14	100TX	Down	Enable	0	0	0	0	0	0
Port.15	100TX	Down	Enable	0	0	0	0	0	0
Port.16	100TX	Down	Enable	0	0	0	0	0	0

Port Statistics interface

The following table describes the labels in this screen.

Label	Description
Type	Show port speed and media type.
Link	Show port link status.
State	Show ports enable or disable.



TX GOOD Packet	The number of good packets sent by this port.
TX Bad Packet	The number of bad packets sent by this port.
RX GOOD Packet	The number of good packets received by this port.
RX Bad Packet	The number of bad packets received by this port.
TX Abort Packet	The number of packets aborted by this port.
Packet Collision	The number of times a collision detected by this port.
Clear	Clear all counters.
Help	Show help file.

5.1.14.4 Port Monitoring

Port monitoring function supports TX (egress) only, RX (ingress) only, and both TX/RX monitoring. TX monitoring sends any data that egress out checked TX source ports to a selected TX destination port as well. RX monitoring sends any data that ingress in checked RX source ports out to a selected RX destination port as well as sending the frame where it normally would have gone. Note that keep all source ports unchecked in order to disable port monitoring.

Port Monitoring

Port	Destination Port		Source Port	
	RX	TX	RX	TX
Port.01	<input checked="" type="radio"/>	<input checked="" type="radio"/>	<input type="checkbox"/>	<input type="checkbox"/>
Port.02	<input type="radio"/>	<input type="radio"/>	<input type="checkbox"/>	<input type="checkbox"/>
Port.03	<input type="radio"/>	<input type="radio"/>	<input type="checkbox"/>	<input type="checkbox"/>
Port.04	<input type="radio"/>	<input type="radio"/>	<input type="checkbox"/>	<input type="checkbox"/>
Port.05	<input type="radio"/>	<input type="radio"/>	<input type="checkbox"/>	<input type="checkbox"/>
Port.06	<input type="radio"/>	<input type="radio"/>	<input type="checkbox"/>	<input type="checkbox"/>
Port.07	<input type="radio"/>	<input type="radio"/>	<input type="checkbox"/>	<input type="checkbox"/>
Port.08	<input type="radio"/>	<input type="radio"/>	<input type="checkbox"/>	<input type="checkbox"/>
Port.09	<input type="radio"/>	<input type="radio"/>	<input type="checkbox"/>	<input type="checkbox"/>
Port.10	<input type="radio"/>	<input type="radio"/>	<input type="checkbox"/>	<input type="checkbox"/>
Port.11	<input type="radio"/>	<input type="radio"/>	<input type="checkbox"/>	<input type="checkbox"/>
Port.12	<input type="radio"/>	<input type="radio"/>	<input type="checkbox"/>	<input type="checkbox"/>
Port.13	<input type="radio"/>	<input type="radio"/>	<input type="checkbox"/>	<input type="checkbox"/>
Port.14	<input type="radio"/>	<input type="radio"/>	<input type="checkbox"/>	<input type="checkbox"/>
Port.15	<input type="radio"/>	<input type="radio"/>	<input type="checkbox"/>	<input type="checkbox"/>
Port.16	<input type="radio"/>	<input type="radio"/>	<input type="checkbox"/>	<input type="checkbox"/>

Port monitoring interface

The following table describes the labels in this screen.

Label	Description
Destination Port	The port will receive a copied frame from source port for monitoring purpose.
Source Port	The port will be monitored. Mark the blank of TX or RX to be monitored.
TX	The frames come into switch port.
RX	The frames receive by switch port.
Apply	Click " Apply " to activate the configurations.
Clear	Clear all marked blank.(disable the function)
Help	Show help file.

5.1.14.5 System Event Log

If system log client is enabled, the system event logs will be shown in this table.

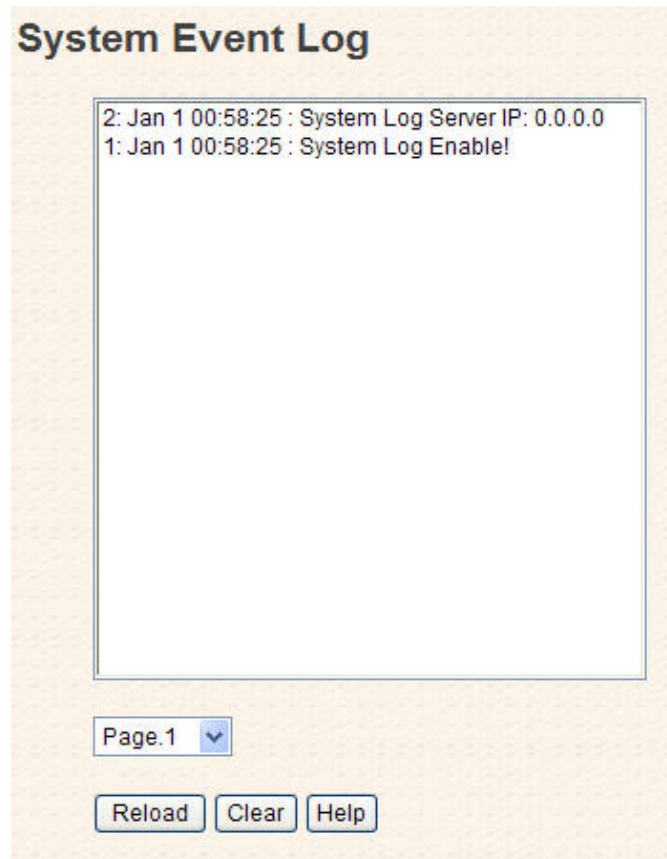

System event log interface

The following table describes the labels in this screen.

Label	Description
Page	Select LOG page.
Reload	To get the newest event logs and refresh this page.
Clear	Clear log.
Help	Show help file.

5.1.14.6 Ping

Ping function allows the switch to send ICMP packets to detect the remote notes.

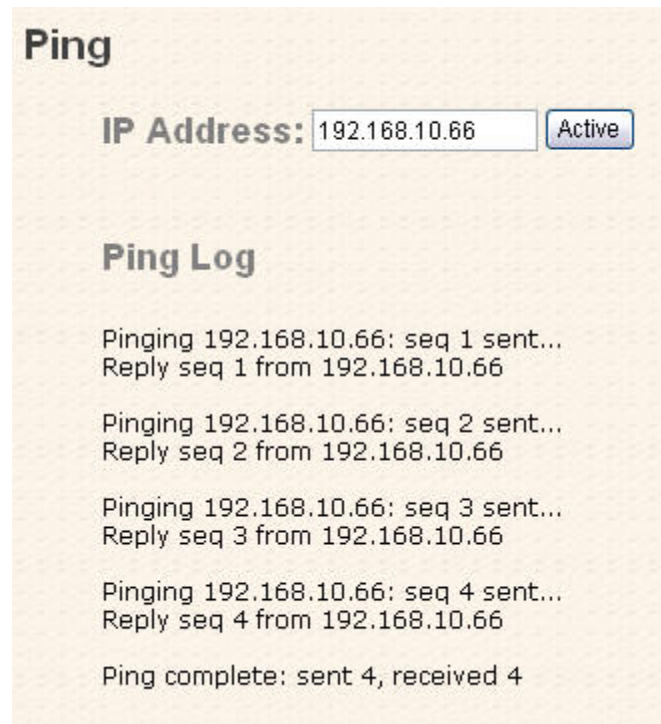

Ping interface

The following table describes the labels in this screen.

Label	Description
IP Address	Enter the IP address that you want to detect.
Active	Click "Active" to send ICMP packets

5.1.15 Save Configuration

If any configuration changed, "**Save Configuration**" should be clicked to save current configuration data to the permanent flash memory. Otherwise, the current configuration will be lost when power off or system reset.

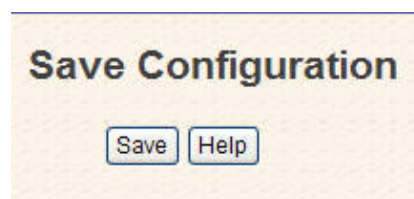

System Configuration interface

The following table describes the labels in this screen.

Label	Description
Save	Save all configurations.
Help	Show help file.

5.1.16 Factory Default

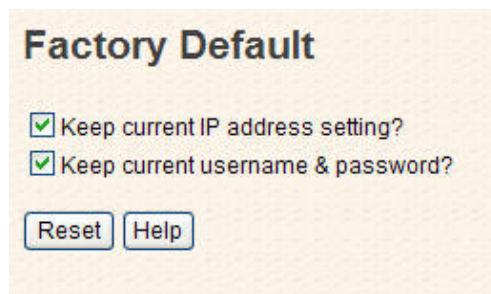

Factory Default interface

Reset switch to default configuration. Click **Reset** to reset all configurations to the default value. You can select “**Keep current IP address setting**” and “**Keep current username & password**” to keep current IP and username and password.

5.1.17 System Reboot

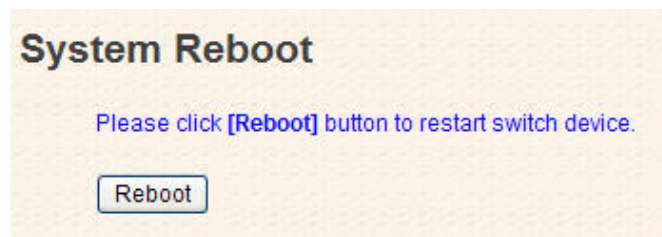

System Reboot interface

Command Line Interface Management

6.1 About CLI Management

Besides WEB-base management, IES-3160 also support CLI management. You can use console or telnet to management switch by CLI.

CLI Management by RS-232 Serial Console (9600, 8, none, 1, none)

Before Configuring by RS-232 serial console, use an RJ45 to DB9-F cable to connect the Switches' RS-232 Console port to your PC's COM port.

Follow the steps below to access the console via RS-232 serial cable.

Step 1. From the Windows desktop, click on Start -> Programs -> Accessories -> Communications -> Hyper Terminal

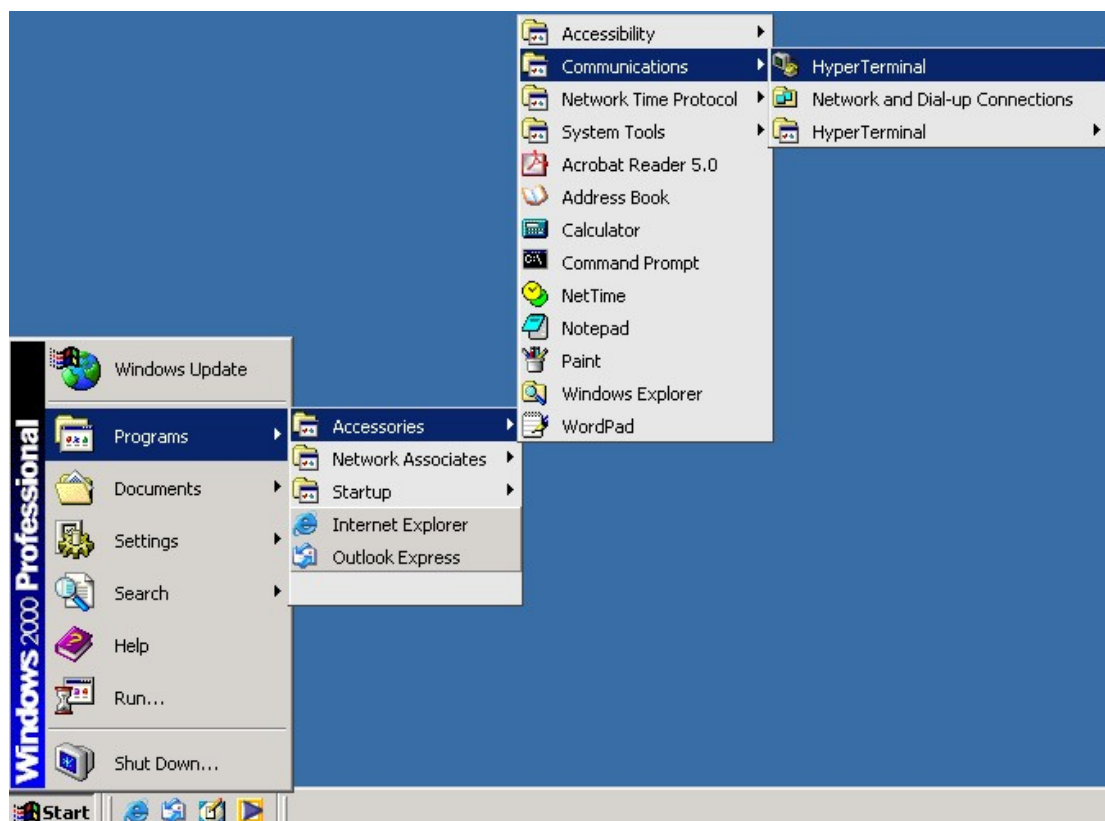

Step 2. Input a name for new connection

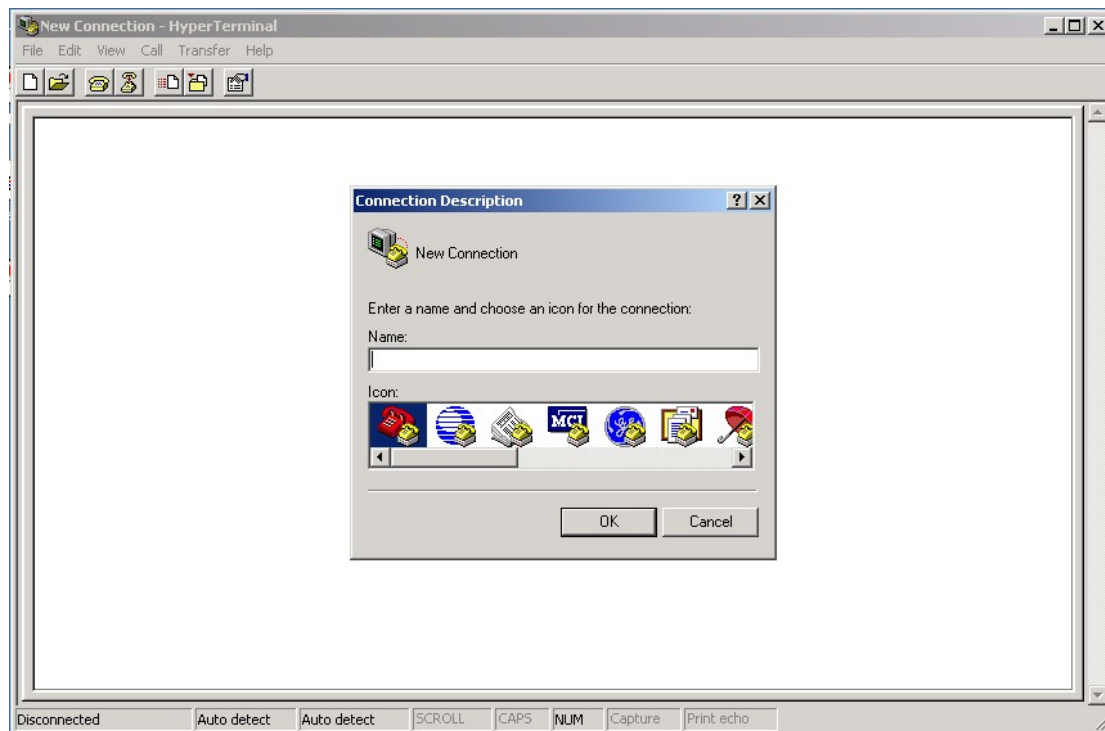

Step 3. Select to use COM port number

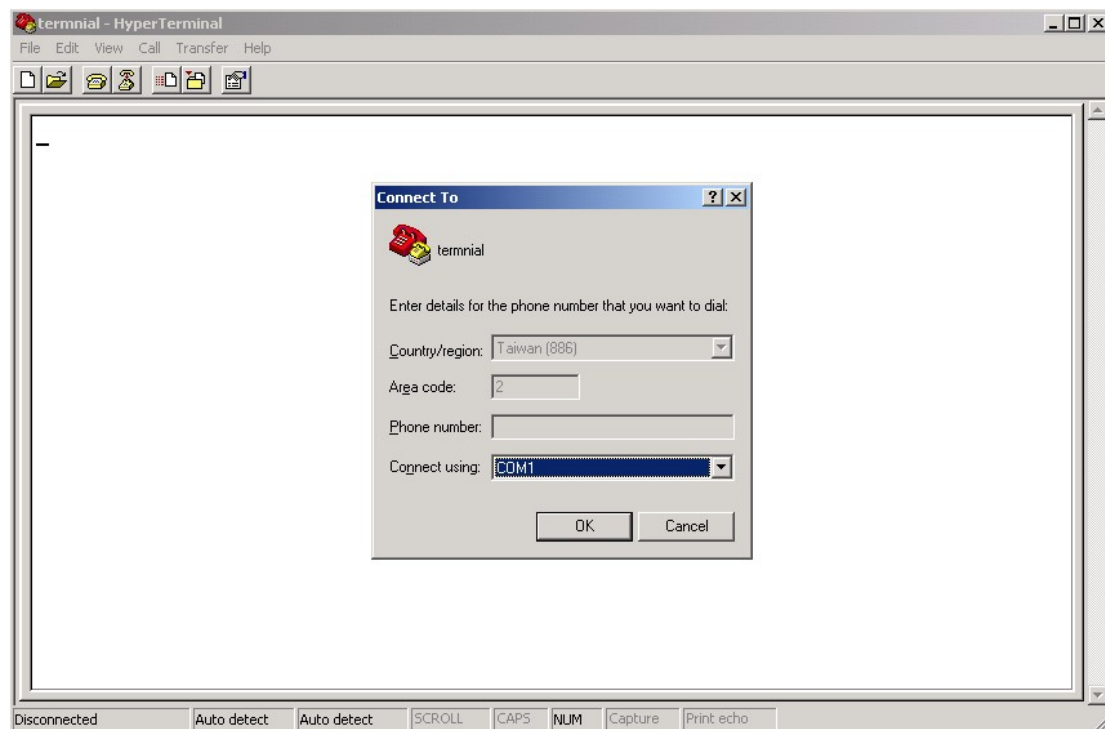

Step 4. The COM port properties setting, 9600 for Bits per second, 8 for Data bits, None for Parity, 1 for Stop bits and none for Flow control.

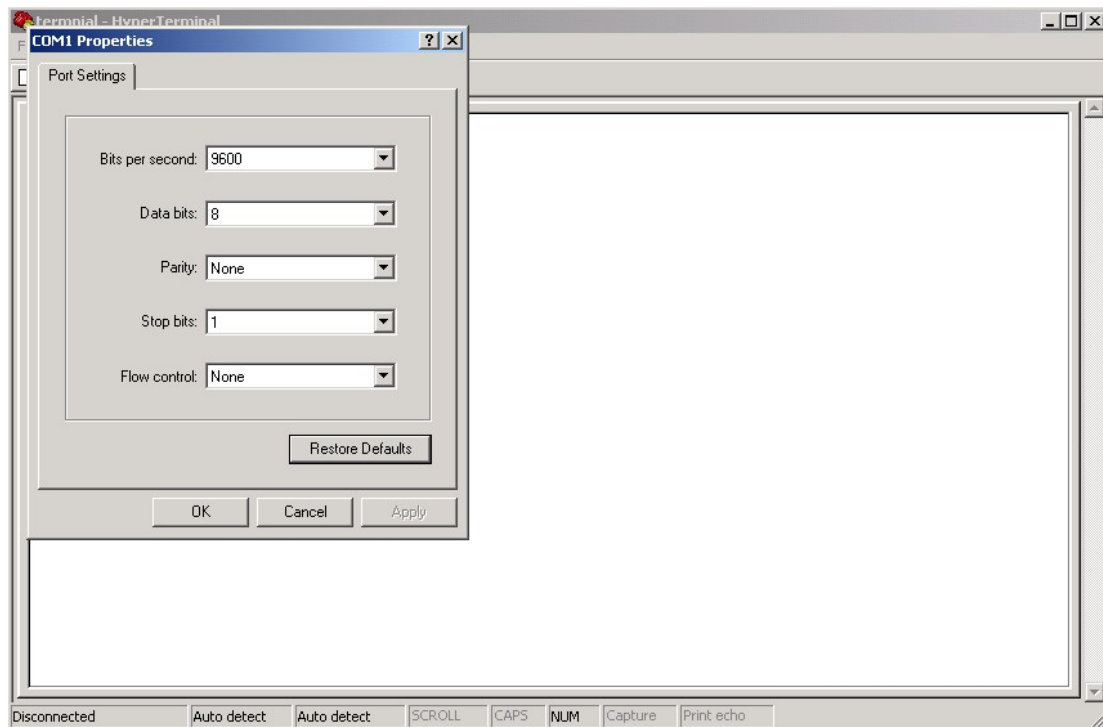

Step 5. The Console login screen will appear. Use the keyboard to enter the Username and Password (The same with the password for Web Browser), then press "Enter".

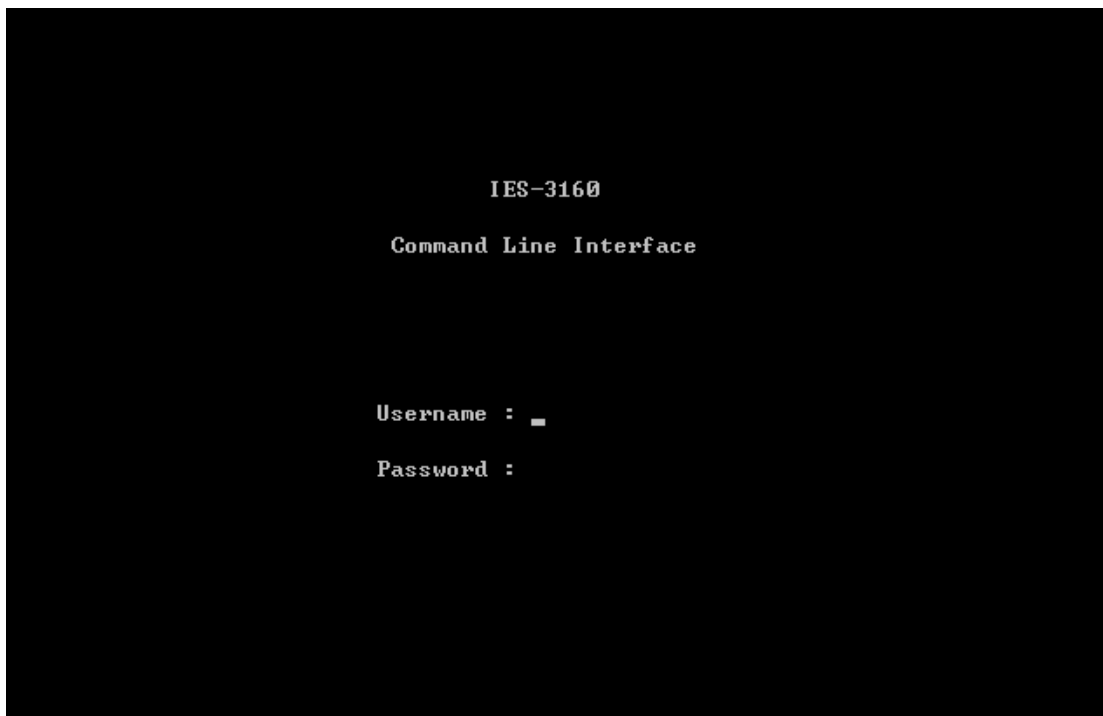

CLI Management by Telnet

Users can use "TELNET" to configure the switches.

The default value is as below:

IP Address: **192.168.10.1**

Subnet Mask: **255.255.255.0**

Default Gateway: **192.168.10.254**

User Name: **admin**

Password: **admin**

Follow the steps below to access the console via Telnet.

Step 1. Telnet to the IP address of the switch from the Windows "Run" command (or from the MS-DOS prompt) as below.

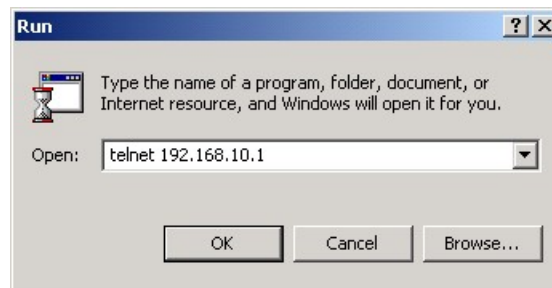

Step 2. The Login screen will appear. Use the keyboard to enter the Username and Password (The same with the password for Web Browser), and then press "Enter"

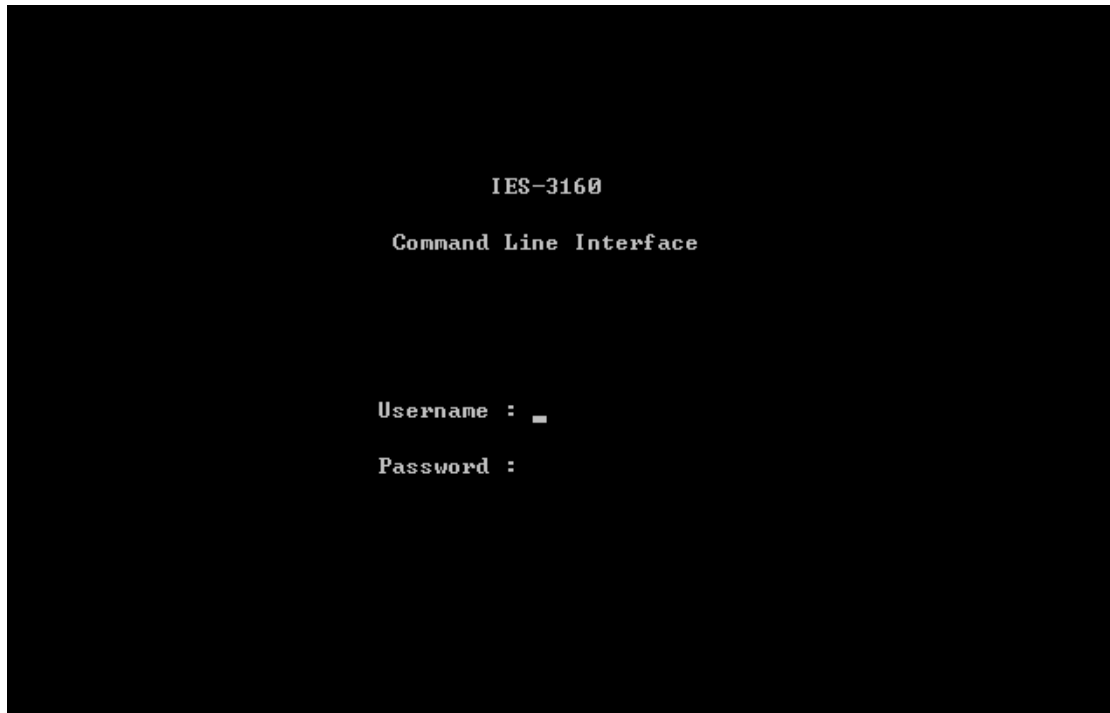



Commands Level

Modes	Access Method	Prompt	Exit Method	About This Model
User EXEC	Begin a session with your switch.	switch>	Enter logout or quit .	The user command available at the level of user is the subset of those available at the privileged level. Use this mode to <ul style="list-style-type: none"> • Enter menu mode. • Display system information.
Privileged EXEC	Enter the enable command while in user EXEC mode.	switch#	Enter disable to exit.	The privileged command is advance mode Privileged this mode to <ul style="list-style-type: none"> • Display advance function status • save configures
Global configuration	Enter the configure command while in privileged EXEC mode.	switch(configuration)#	To exit to privileged EXEC mode, enter exit or end	Use this mode to configure parameters that apply to your Switch as a whole.
VLAN database	Enter the vlan database command while in privileged EXEC mode.	switch(vlan)#	To exit to user EXEC mode, enter exit .	Use this mode to configure VLAN-specific parameters.
Interface configuration	Enter the interface command (with a specific interface)while in global configuration mode	switch(configuration-if)#	To exit to global configuration mode, enter exit . To exist privileged EXEC mode or end .	Use this mode to configure parameters for the switch and Ethernet ports.

Symbol of Command Level.

Mode	Symbol of Command Level
User EXEC	E
Privileged EXEC	P
Global configuration	G
VLAN database	V
Interface configuration	I

6.2 Commands Set List—System Commands Set

IES-3160 Commands	Level	Description	Example
show config	E	Show switch configuration	switch>show config
show terminal	P	Show console information	switch#show terminal
write memory	P	Save your configuration into permanent memory (flash rom)	switch#write memory
system name [System Name]	G	Configure system name	switch(config)#system name xxx
system location [System Location]	G	Set switch system location string	switch(config)#system location xxx
system description [System Description]	G	Set switch system description string	switch(config)#system description xxx
system contact [System Contact]	G	Set switch system contact window string	switch(config)#system contact xxx
show system-info	E	Show system information	switch>show system-info
ip address [Ip-address] [Subnet-mask] [Gateway]	G	Configure the IP address of switch	switch(config)#ip address 192.168.1.1 255.255.255.0 192.168.1.254
ip dhcp	G	Enable DHCP client function of switch	switch(config)#ip dhcp



show ip	P	Show IP information of switch	switch#show ip
no ip dhcp	G	Disable DHCP client function of switch	switch(config)#no ip dhcp
reload	G	Halt and perform a cold restart	switch(config)#reload
default	G	Restore to default	Switch(config)#default
admin username [Username]	G	Changes a login username. (maximum 10 words)	switch(config)#admin username xxxxxx
admin password [Password]	G	Specifies a password (maximum 10 words)	switch(config)#admin password xxxxxx
show admin	P	Show administrator information	switch#show admin
dhcpserver enable	G	Enable DHCP Server	switch(config)#dhcpserver enable
dhcpserver lowip [Low IP]	G	Configure low IP address for IP pool	switch(config)# dhcpserver lowip 192.168.1.1
dhcpserver highip [High IP]	G	Configure high IP address for IP pool	switch(config)# dhcpserver highip 192.168.1.50
dhcpserver subnetmask [Subnet mask]	G	Configure subnet mask for DHCP clients	switch(config)#dhcpserver subnetmask 255.255.255.0
dhcpserver gateway [Gateway]	G	Configure gateway for DHCP clients	switch(config)#dhcpserver gateway 192.168.1.254
dhcpserver dnsip [DNS IP]	G	Configure DNS IP for DHCP clients	switch(config)# dhcpserver dnsip 192.168.1.1
dhcpserver leasetime [Hours]	G	Configure lease time (in hour)	switch(config)#dhcpserver leasetime 1
dhcpserver ipbinding [IP address]	I	Set static IP for DHCP clients by port	switch(config)#interface fastEthernet 2 switch(config-if)#dhcpserver ipbinding 192.168.1.1
show dhcpserver configuration	P	Show configuration of DHCP server	switch#show dhcpserver configuration
show dhcpserver clients	P	Show client entries of DHCP server	switch#show dhcpserver clinets
show dhcpserver ip-binding	P	Show IP-Binding information of DHCP	switch#show dhcpserver ip-binding

		server	
no dhcpserver	G	Disable DHCP server function	switch(config)#no dhcpserver
security enable	G	Enable IP security function	switch(config)#security enable
security http	G	Enable IP security of HTTP server	switch(config)#security http
security telnet	G	Enable IP security of telnet server	switch(config)#security telnet
security ip [Index(1..10)] [IP Address]	G	Set the IP security list	switch(config)#security ip 1 192.168.1.55
show security	P	Show the information of IP security	switch#show security
no security	G	Disable IP security function	switch(config)#no security
no security http	G	Disable IP security of HTTP server	switch(config)#no security http
no security telnet	G	Disable IP security of telnet server	switch(config)#no security telnet

6.3 Commands Set List—Port Commands Set

IES-3160 Commands	Level	Description	Example
interface fastEthernet [Portid]	G	Choose the port for modification.	switch(config)#interface fastEthernet 2
duplex [full half]	I	Use the duplex configuration command to specify the duplex mode of operation for Fast Ethernet.	switch(config)#interface fastEthernet 2 switch(config-if)#duplex full
speed [10 100 1000 auto]	I	Use the speed configuration command to specify the speed mode of operation for Fast	switch(config)#interface fastEthernet 2 switch(config-if)#speed 100

		Ethernet., the speed can't be set to 1000 if the port isn't a giga port..	
flowcontrol mode [Symmetric Asymmetric]	I	Use the flowcontrol configuration command on Ethernet ports to control traffic rates during congestion.	switch(config)#interface fastEthernet 2 switch(config-if)#flowcontrol mode Asymmetric
no flowcontrol	I	Disable flow control of interface	switch(config-if)#no flowcontrol
security enable	I	Enable security of interface	switch(config)#interface fastEthernet 2 switch(config-if)#security enable
no security	I	Disable security of interface	switch(config)#interface fastEthernet 2 switch(config-if)#no security
bandwidth type all	I	Set interface ingress limit frame type to "accept all frame"	switch(config)#interface fastEthernet 2 switch(config-if)#bandwidth type all
bandwidth type broadcast-multicast-flooded-unicast	I	Set interface ingress limit frame type to "accept broadcast, multicast, and flooded unicast frame"	switch(config)#interface fastEthernet 2 switch(config-if)#bandwidth type broadcast-multicast-flooded-unicast
bandwidth type broadcast-multicast	I	Set interface ingress limit frame type to "accept broadcast and multicast frame"	switch(config)#interface fastEthernet 2 switch(config-if)#bandwidth type broadcast-multicast
bandwidth type broadcast-only	I	Set interface ingress limit frame type to "only accept broadcast frame"	switch(config)#interface fastEthernet 2 switch(config-if)#bandwidth type broadcast-only
bandwidth in [Value]	I	Set interface input bandwidth. Rate Range is from 100	switch(config)#interface fastEthernet 2 switch(config-if)#bandwidth in 100

		<p>kbps to 102400 kbps or to 256000 kbps for giga ports, and zero means no limit.</p>	
<p>bandwidth out [Value]</p>	I	<p>Set interface output bandwidth. Rate Range is from 100 kbps to 102400 kbps or to 256000 kbps for giga ports, and zero means no limit.</p>	<p>switch(config)#interface fastEthernet 2 switch(config-if)#bandwidth out 100</p>
<p>show bandwidth</p>	I	<p>Show interfaces bandwidth control</p>	<p>switch(config)#interface fastEthernet 2 switch(config-if)#show bandwidth</p>
<p>state [Enable Disable]</p>	I	<p>Use the state interface configuration command to specify the state mode of operation for Ethernet ports. Use the disable form of this command to disable the port.</p>	<p>switch(config)#interface fastEthernet 2 switch(config-if)#state Disable</p>
<p>show interface configuration</p>	I	<p>show interface configuration status</p>	<p>switch(config)#interface fastEthernet 2 switch(config-if)#show interface configuration</p>
<p>show interface status</p>	I	<p>show interface actual status</p>	<p>switch(config)#interface fastEthernet 2 switch(config-if)#show interface status</p>
<p>show interface accounting</p>	I	<p>show interface statistic counter</p>	<p>switch(config)#interface fastEthernet 2 switch(config-if)#show interface</p>



			accounting
no accounting	I	Clear interface accounting information	switch(config)#interface fastEthernet 2 switch(config-if)#no accounting

6.4 Commands Set List—Trunk command set

IES-3160 Commands	Level	Description	Example
aggregator priority [1to65535]	G	Set port group system priority	switch(config)#aggregator priority 22
aggregator activityport [Port Numbers]	G	Set activity port	switch(config)#aggregator activityport 2
aggregator group [GroupID] [Port-list] lacp workp [Workport]	G	Assign a trunk group with LACP active. [GroupID] :1to3 [Port-list]:Member port list, This parameter could be a port range(ex.1-4) or a port list separate by a comma(ex.2, 3, 6) [Workport]: The amount of work ports, this value could not be less than zero or be large than the amount of member ports.	switch(config)#aggregator group 1 1-4 lacp workp 2 or switch(config)#aggregator group 2 1,4,3 lacp workp 3
aggregator group [GroupID] [Port-list] nolacp	G	Assign a static trunk group. [GroupID] :1to3 [Port-list]:Member port list, This parameter could be a port range(ex.1-4) or a port list separate by a comma(ex.2, 3, 6)	switch(config)#aggregator group 1 2-4 nolacp or switch(config)#aggregator group 1 3,1,2 nolacp

show aggregator	P	Show the information of trunk group	switch#show aggregator
no aggregator lacp [GroupID]	G	Disable the LACP function of trunk group	switch(config)#no aggregator lacp 1
no aggregator group [GroupID]	G	Remove a trunk group	switch(config)#no aggregator group 2

6.5 Commands Set List—VLAN command set

IES-3160 Commands	Level	Description	Example
vlan database	P	Enter VLAN configure mode	switch#vlan database
vlan [8021q gvrp]	V	To set switch VLAN mode.	switch(vlan)# vlanmode 802.1q or switch(vlan)# vlanmode gvrp
no vlan [VID]	V	Disable vlan group(by VID)	switch(vlan)#no vlan 2
no gvrp	V	Disable GVRP	switch(vlan)#no gvrp
IEEE 802.1Q VLAN			
vlan 8021q port [PortNumber] access-link untag [UntaggedVID]	V	Assign a access link for VLAN by port, if the port belong to a trunk group, this command can't be applied.	switch(vlan)#vlan 802.1q port 3 access-link untag 33
vlan 8021q port [PortNumber] trunk-link tag [TaggedVID List]	V	Assign a trunk link for VLAN by port, if the port belong to a trunk group, this command can't be applied.	switch(vlan)#vlan 8021q port 3 trunk-link tag 2,3,6,99 or switch(vlan)#vlan 8021q port 3 trunk-link tag 3-20
vlan 8021q port [PortNumber] hybrid-link untag [UntaggedVID] tag [TaggedVID List]	V	Assign a hybrid link for VLAN by port, if the port belong to a trunk group, this command can't be applied.	switch(vlan)# vlan 8021q port 3 hybrid-link untag 4 tag 3,6,8 or switch(vlan)# vlan 8021q port 3 hybrid-link untag 5 tag 6-8
vlan 8021q aggregator [TrunkID]	V	Assign a access link for VLAN by trunk	switch(vlan)#vlan 8021q aggregator 3 access-link untag 33

access-link untag [UntaggedVID]		group	
vlan 8021q aggregator [TrunkID] trunk-link tag [TaggedVID List]	V	Assign a trunk link for VLAN by trunk group	switch(vlan)#vlan 8021q aggregator 3 trunk-link tag 2,3,6,99 or switch(vlan)#vlan 8021q aggregator 3 trunk-link tag 3-20
vlan 8021q aggregator [PortNumber] hybrid-link untag [UntaggedVID] tag [TaggedVID List]	V	Assign a hybrid link for VLAN by trunk group	switch(vlan)# vlan 8021q aggregator 3 hybrid-link untag 4 tag 3,6,8 or switch(vlan)# vlan 8021q aggregator 3 hybrid-link untag 5 tag 6-8
show vlan [VID] or show vlan	V	Show VLAN information	switch(vlan)#show vlan 23

6.6 Commands Set List—Spanning Tree command set

IES-3160 Commands	Level	Description	Example
spanning-tree enable	G	Enable spanning tree	switch(config)#spanning-tree enable
spanning-tree priority [0to61440]	G	Configure spanning tree priority parameter	switch(config)#spanning-tree priority 32767
spanning-tree max-age [seconds]	G	Use the spanning-tree max-age global configuration command to change the interval between messages the spanning tree receives from the root switch. If a switch does not receive a bridge protocol data unit (BPDU) message	switch(config)# spanning-tree max-age 15

		from the root switch within this interval, it recomputed the Spanning Tree Protocol (STP) topology.	
spanning-tree hello-time [seconds]	G	Use the spanning-tree hello-time global configuration command to specify the interval between hello bridge protocol data units (BPDUs).	switch(config)#spanning-tree hello-time 3
spanning-tree forward-time [seconds]	G	Use the spanning-tree forward-time global configuration command to set the forwarding-time for the specified spanning-tree instances. The forwarding time determines how long each of the listening and learning states last before the port begins forwarding.	switch(config)# spanning-tree forward-time 20
stp-path-cost [1to200000000]	I	Use the spanning-tree cost interface configuration command to set the path cost for Spanning Tree Protocol (STP) calculations. In the event of a loop,	switch(config)#interface fastEthernet 2 switch(config-if)#stp-path-cost 20

		spanning tree considers the path cost when selecting an interface to place into the forwarding state.	
stp-path-priority [Port Priority]	I	Use the spanning-tree port-priority interface configuration command to configure a port priority that is used when two switches tie for position as the root switch.	switch(config)#interface fastEthernet 2 switch(config-if)# stp-path-priority 127
stp-admin-p2p [Auto True False]	I	Admin P2P of STP priority on this interface.	switch(config)#interface fastEthernet 2 switch(config-if)# stp-admin-p2p Auto
stp-admin-edge [True False]	I	Admin Edge of STP priority on this interface.	switch(config)#interface fastEthernet 2 switch(config-if)# stp-admin-edge True
stp-admin-non-stp [True False]	I	Admin NonSTP of STP priority on this interface.	switch(config)#interface fastEthernet 2 switch(config-if)# stp-admin-non-stp False
Show spanning-tree	E	Display a summary of the spanning-tree states.	switch>show spanning-tree
no spanning-tree	G	Disable spanning-tree.	switch(config)#no spanning-tree

6.7 Commands Set List—QoS command set

IES-3160 Commands	Level	Description	Example
qos policy	G	Select QOS policy	switch(config)#qos policy

[weighted-fair strict]		scheduling	weighted-fair
qos prioritytype [port-based cos-only tos-only cos-first tos-first]	G	Setting of QOS priority type	switch(config)#qos prioritytype
qos priority portbased [Port] [lowest low middle high]	G	Configure Port-based Priority	switch(config)#qos priority portbased 1 low
qos priority cos [Priority][lowest low middle high]	G	Configure COS Priority	switch(config)#qos priority cos 22 middle
qos priority tos [Priority][lowest low middle high]	G	Configure TOS Priority	switch(config)#qos priority tos 3 high
show qos	P	Display the information of QoS configuration	switch>show qos
no qos	G	Disable QoS function	switch(config)#no qos

6.8 Commands Set List—IGMP command set

IES-3160 Commands	Level	Description	Example
igmp enable	G	Enable IGMP snooping function	switch(config)#igmp enable
igmp-query auto	G	Set IGMP query to auto mode	switch(config)#igmp-query auto
igmp-query force	G	Set IGMP query to force mode	switch(config)#igmp-query force
show igmp configuration	P	Displays the details of an IGMP configuration.	switch#show igmp configuration
show igmp multi	P	Displays the details of an IGMP snooping entries.	switch#show igmp multi
no igmp	G	Disable IGMP snooping function	switch(config)#no igmp
no igmp-query	G	Disable IGMP query	switch#no igmp-query

6.9 Commands Set List—MAC/Filter Table command set

IES-3160 Commands	Level	Description	Example
mac-address-table static hwaddr [MAC]	I	Configure MAC address table of interface (static).	switch(config)#interface fastEthernet 2 switch(config-if)#mac-address-table static hwaddr 000012345678
mac-address-table filter hwaddr [MAC]	G	Configure MAC address table(filter)	switch(config)#mac-address-table filter hwaddr 000012348678
show mac-address-table	P	Show all MAC address table	switch#show mac-address-table
show mac-address-table static	P	Show static MAC address table	switch#show mac-address-table static
show mac-address-table filter	P	Show filter MAC address table.	switch#show mac-address-table filter
no mac-address-table static hwaddr [MAC]	I	Remove an entry of MAC address table of interface (static)	switch(config)#interface fastEthernet 2 switch(config-if)#no mac-address-table static hwaddr 000012345678
no mac-address-table filter hwaddr [MAC]	G	Remove an entry of MAC address table (filter)	switch(config)#no mac-address-table filter hwaddr 000012348678
no mac-address-table	G	Remove dynamic entry of MAC address table	switch(config)#no mac-address-table

6.10 Commands Set List—SNMP command set

IES-3160 Commands	Level	Description	Example
snmp agent-mode [v1v2c v3]	G	Select the agent mode of SNMP	switch(config)#snmp agent-mode v1v2c
snmp-server host [IP address]	G	Configure SNMP server host	switch(config)#snmp-server host 192.168.10.50 community public

community [Community-string] trap-version [v1 v2c]		information and community string	trap-version v1 (remove) Switch(config)# no snmp-server host 192.168.10.50
snmp community-strings [Community-string] right [RO RW]	G	Configure the community string right	switch(config)#snmp community-strings public right RO or switch(config)#snmp community-strings public right RW
snmp snmpv3-user [User Name] password [Authentication Password] [Privacy Password]	G	Configure the userprofile for SNMPV3 agent. Privacy password could be empty.	switch(config)#snmp snmpv3-user test01 password AuthPW PrivPW
show snmp	P	Show SNMP configuration	switch#show snmp
show snmp-server	P	Show specified trap server information	switch#show snmp-server
no snmp community-strings [Community]	G	Remove the specified community.	switch(config)#no snmp community-strings public
no snmp snmpv3-user [User Name] password [Authentication Password] [Privacy Password]	G	Remove specified user of SNMPv3 agent. Privacy password could be empty.	switch(config)# no snmp snmpv3-user test01 password AuthPW PrivPW
no snmp-server host [Host-address]	G	Remove the SNMP server host.	switch(config)#no snmp-server 192.168.10.50

6.11 Commands Set List—Port Mirroring command set

IES-3160 Commands	Level	Description	Example
monitor rx	G	Set RX destination port of monitor	switch(config)#monitor rx

		function	
monitor tx	G	Set TX destination port of monitor function	switch(config)#monitor tx
show monitor	P	Show port monitor information	switch#show monitor
monitor [RX TX Both]	I	Configure source port of monitor function	switch(config)#interface fastEthernet 2 switch(config-if)#monitor RX
show monitor	I	Show port monitor information	switch(config)#interface fastEthernet 2 switch(config-if)#show monitor
no monitor	I	Disable source port of monitor function	switch(config)#interface fastEthernet 2 switch(config-if)#no monitor

6.12 Commands Set List—802.1x command set

IES-3160 Commands	Level	Description	Example
8021x enable	G	Use the 802.1x global configuration command to enable 802.1x protocols.	switch(config)# 8021x enable
8021x system radiusip [IP address]	G	Use the 802.1x system radius IP global configuration command to change the radius server IP.	switch(config)# 8021x system radiusip 192.168.1.1
8021x system serverport [port ID]	G	Use the 802.1x system server port global configuration command to change the radius server port	switch(config)# 8021x system serverport 1815
8021x system accountport [port ID]	G	Use the 802.1x system account port global configuration command to change	switch(config)# 8021x system accountport 1816



		the accounting port	
8021x system sharekey [ID]	G	Use the 802.1x system share key global configuration command to change the shared key value.	switch(config)# 8021x system sharekey 123456
8021x system nasid [words]	G	Use the 802.1x system nasid global configuration command to change the NAS ID	switch(config)# 8021x system nasid test1
8021x misc quietperiod [sec.]	G	Use the 802.1x misc quiet period global configuration command to specify the quiet period value of the switch.	switch(config)# 8021x misc quietperiod 10
8021x misc txperiod [sec.]	G	Use the 802.1x misc TX period global configuration command to set the TX period.	switch(config)# 8021x misc txperiod 5
8021x misc supportimeout [sec.]	G	Use the 802.1x misc supp timeout global configuration command to set the supplicant timeout.	switch(config)# 8021x misc supportimeout 20
8021x misc servertimeout [sec.]	G	Use the 802.1x misc server timeout global configuration command to set the server timeout.	switch(config)#8021x misc servertimeout 20
8021x misc maxrequest [number]	G	Use the 802.1x misc max request global configuration command to set the	switch(config)# 8021x misc maxrequest 3

		MAX requests.	
8021x misc reauthperiod [sec.]	G	Use the 802.1x misc reauth period global configuration command to set the reauth period.	switch(config)# 8021x misc reauthperiod 3000
8021x portstate [disable reject accept authorize]	I	Use the 802.1x port state interface configuration command to set the state of the selected port.	switch(config)#interface fastethernet 3 switch(config-if)#8021x portstate accept
show 8021x	E	Display a summary of the 802.1x properties and also the port sates.	switch>show 8021x
no 8021x	G	Disable 802.1x function	switch(config)#no 8021x

6.13 Commands Set List—TFTP command set

IES-3160 Commands	Level	Description	Defaults Example
backup flash:backup_cfg	G	Save configuration to TFTP and need to specify the IP of TFTP server and the file name of image.	switch(config)#backup flash:backup_cfg
restore flash:restore_cfg	G	Get configuration from TFTP server and need to specify the IP of TFTP server and the file name of image.	switch(config)#restore flash:restore_cfg

upgrade flash:upgrade_fw	G	Upgrade firmware by TFTP and need to specify the IP of TFTP server and the file name of image.	switch(config)#upgrade lash:upgrade_fw
---	----------	--	---

6.14 Commands Set List—SYSLOG, SMTP, EVENT command set

IES-3160 Commands	Level	Description	Example
systemlog ip [IP address]	G	Set System log server IP address.	switch(config)# systemlog ip 192.168.1.100
systemlog mode [client server both]	G	Specified the log mode	switch(config)# systemlog mode both
show systemlog	E	Display system log.	Switch>show systemlog
show systemlog	P	Show system log client & server information	switch#show systemlog
no systemlog	G	Disable systemlog function	switch(config)#no systemlog
smtp enable	G	Enable SMTP function	switch(config)#smtp enable
smtp serverip [IP address]	G	Configure SMTP server IP	switch(config)#smtp serverip 192.168.1.5
smtp authentication	G	Enable SMTP authentication	switch(config)#smtp authentication
smtp account [account]	G	Configure authentication account	switch(config)#smtp account User
smtp password [password]	G	Configure authentication password	switch(config)#smtp password
smtp rcptemail [Index] [Email address]	G	Configure Rcpt e-mail Address	switch(config)#smtp rcptemail 1 Alert@test.com
show smtp	P	Show the information of SMTP	switch#show smtp
no smtp	G	Disable SMTP	switch(config)#no smtp



		function	
event device-cold-start [Systemlog SMTP Both]	G	Set cold start event type	switch(config)#event device-cold-start both
event authentication-failure [Systemlog SMTP Both]	G	Set Authentication failure event type	switch(config)#event authentication-failure both
event O-Ring-topology-change [Systemlog SMTP Both]	G	Set s ring topology changed event type	switch(config)#event ring-topology-change both
event systemlog [Link-UP Link-Down Both]	I	Set port event for system log	switch(config)#interface fastethernet 3 switch(config-if)#event systemlog both
event smtp [Link-UP Link-Down Both]	I	Set port event for SMTP	switch(config)#interface fastethernet 3 switch(config-if)#event smtp both
show event	P	Show event selection	switch#show event
no event device-cold-start	G	Disable cold start event type	switch(config)#no event device-cold-start
no event authentication-failure	G	Disable Authentication failure event typ	switch(config)#no event authentication-failure
no event O-Ring-topology-change	G	Disable O-Ring topology changed event type	switch(config)#no event ring-topology-change
no event systemlog	I	Disable port event for system log	switch(config)#interface fastethernet 3 switch(config-if)#no event systemlog
no event smtp	I	Disable port event for SMTP	switch(config)#interface fastethernet 3 switch(config-if)#no event smtp
show systemlog	P	Show system log client & server information	switch#show systemlog

6.15 Commands Set List—SNTP command set

IES-3160 Commands	Level	Description	Example
-------------------	-------	-------------	---------

sntp enable	G	Enable SNTP function	switch(config)#sntp enable
sntp daylight	G	Enable daylight saving time, if SNTP function is inactive, this command can't be applied.	switch(config)#sntp daylight
sntp daylight-period [Start time] [End time]	G	Set period of daylight saving time, if SNTP function is inactive, this command can't be applied. Parameter format: [yyyymmdd-hh:mm]	switch(config)# sntp daylight-period 20060101-01:01 20060202-01-01
sntp daylight-offset [Minute]	G	Set offset of daylight saving time, if SNTP function is inactive, this command can't be applied.	switch(config)#sntp daylight-offset 3
sntp ip [IP]	G	Set SNTP server IP, if SNTP function is inactive, this command can't be applied.	switch(config)#sntp ip 192.169.1.1
sntp timezone [Timezone]	G	Set timezone index, use "show sntp timzezone" command to get more information of index number	switch(config)#sntp timezone 22
show sntp	P	Show SNTP information	switch#show sntp
show sntp timezone	P	Show index number of time zone list	switch#show sntp timezone
no sntp	G	Disable SNTP function	switch(config)#no sntp
no sntp daylight	G	Disable daylight	switch(config)#no sntp daylight



		saving time	
--	--	-------------	--

6.16 Commands Set List—O-Ring command set

IES-3160 Commands	Level	Description	Example
Ring enable	G	Enable O-Ring	switch(config)# ring enable
Ring master	G	Enable ring master	switch(config)# ring master
Ring couplering	G	Enable couple ring	switch(config)# ring couplering
Ring dualhoming	G	Enable dual homing	switch(config)# ring dualhoming
Ring ringport [1st Ring Port] [2nd Ring Port]	G	Configure 1st/2nd Ring Port	switch(config)# ring ringport 7 8
Ring couplingport [Coupling Port]	G	Configure Coupling Port	switch(config)# ring couplingport 1
Ring controlport [Control Port]	G	Configure Control Port	switch(config)# ring controlport 2
Ring homingport [Dual Homing Port]	G	Configure Dual Homing Port	switch(config)# ring homingport 3
show Ring	P	Show the information of O-Ring	switch#show ring
no Ring	G	Disable O-Ring	switch(config)#no ring
no Ring master	G	Disable ring master	switch(config)# no ring master
no Ring couplering	G	Disable couple ring	switch(config)# no ring couplering
no Ring dualhoming	G	Disable dual homing	switch(config)# no ring dualhoming

Technical Specifications

Technology	
Ethernet Standards	802.3 - 10Base-T, 802.3u - 100Base-TX 802.3ad - Link Aggregation Control Protocol 802.3x - Flow Control 802.1D - Spanning Tree Protocol 802.1p - Class of Service, 802.1Q - VLAN Tagging 802.1w - Rapid Spanning Tree Protocol, 802.1X - Authentication 802.1ad - VLAN QinQ 802.1AB - LLDP 802.1s - MSTP
MAC addresses	8192
Priority Queues	4
Flow Control	IEEE 802.3x Flow Control and Back-pressure
Processing	Store-and-Forward
Interface	
RJ45 Ports	10/100Base-T(X), Auto MDI/MDI-X
LED Indicators	Per Unit : Power x 3(Green) RJ45 Ports: Per Port : Link/Activity(Green/Blinking Green), Full duplex(Amber)
Power Requirements	
Power Input Voltage	PWR1/2: 12~8VDC on 6-pin Terminal Block
Reverse Polarity Protection	Present
Power Consumption	7.68 Watts
Environmental	
Operating Temperature	-40 to 70 °C
Storage Temperature	-40 to 85 °C
Operating Humidity	5% to 95%, non-condensing
Mechanical	



Dimensions(W x D x H)	74.3 mm(W)x 109.2 mm(D)x 153.6 mm(H)
Casing	IP-30 protection
Regulatory Approvals	
Regulatory Approvals	FCC Part 15, CISPER (EN55022) class A
EMS	EN61000-4-2 (ESD), EN61000-4-3 (RS), EN61000-4-4 (EFT), EN61000-4-5 (Surge), EN61000-4-6 (CS),EN61000-4-8,EN61000-4-11
Shock	IEC 60068-2-27
Free Fall	IEC 60068-2-32
Vibration	IEC 60068-2-6
Warranty	5 years