



IES-2050A

Industrial Lite-Managed Ethernet Switch

User Manual

Version 2.3

Jan, 2021

www.oringnet.com

COPYRIGHT NOTICE

Copyright © 2010 ORing Industrial Networking Corp.

All rights reserved.

No part of this publication may be reproduced in any form without the prior written consent of ORing Industrial Networking Corp.

TRADEMARKS

ORing is a registered trademark of ORing Industrial Networking Corp.

All other trademarks belong to their respective owners.

REGULATORY COMPLIANCE STATEMENT

Product(s) associated with this publication complies/comply with all applicable regulations. Please refer to the Technical Specifications section for more details.

WARRANTY

ORing warrants that all ORing products are free from defects in material and workmanship for a specified warranty period from the invoice date (5 years for most products). ORing will repair or replace products found by ORing to be defective within this warranty period, with shipment expenses apportioned by ORing and the distributor. This warranty does not cover product modifications or repairs done by persons other than ORing-approved personnel, and this warranty does not apply to ORing products that are misused, abused, improperly installed, or damaged by accidents.

Please refer to the Technical Specifications section for the actual warranty period(s) of the product(s) associated with this publication.

DISCLAIMER

Information in this publication is intended to be accurate. ORing shall not be responsible for its use or infringements on third-parties as a result of its use. There may occasionally be unintentional errors on this publication. ORing reserves the right to revise the contents of this publication without notice.

CONTACT INFORMATION

ORing Industrial Networking Corp.

3F., NO.542-2, Jhongjheng Rd., Sindian District, New Taipei City 231, Taiwan, R.O.C.

Tel: + 886 2 2218 1066 // Fax: + 886 2 2218 1014

Website: www.oringnet.com

Technical Support

E-mail: support@oringnet.com

Sales Contact

E-mail: sales@oringnet.com (Headquarters)

sales@oringnet.com.cn (China)

Table of Content

Getting to Know Your Switch.....	4
1.1 About the IES-2050A Lite-Managed Industrial Switch.....	4
1.2 Software Features.....	4
1.3 Hardware Features	4
Hardware Installation.....	5
2.1 Installing Switch on DIN-Rail.....	5
2.1.1 Mount IES-2050A on DIN-Rail	5
2.2 Wall Mounting Installation	5
Hardware Overview	7
3.1 Front Panel	7
3.2 Front Panel LEDs.....	8
3.3 Bottom Panel.....	8
Cables	9
4.1 Ethernet Cables	9
4.1.1 100BASE-TX/10BASE-T Pin Assignments.....	9
WEB Management	11
5.1 Configuration by Web Browser.....	11
5.1.1 About Web-based Management	11
5.1.2 Basic Setting.....	13
5.1.2.1 Switch setting	13
5.1.2.2 Admin Password.....	13
5.1.2.3 IP configuration	14
5.1.2.4 SNTP Configuration	15
5.1.2.5 LLDP.....	17
5.1.2.6 Dip Setting.....	17
5.1.2.7 Backup & Restore	18
5.1.2.8 Upgrade Firmware.....	19
5.1.3 Redundancy	19
5.1.3.1 Fast Recovery Mode	19
5.1.3.2 O-Ring.....	20
5.1.3.3 O-Chain.....	22
5.1.3.4 RSTP.....	23

5.1.4	Port Configuration	26
5.1.4.1	Port Control	26
5.1.4.2	Port Status	27
5.1.4.3	Port Alias	27
5.1.5	VLAN	28
5.1.5.1	VLAN Configuration – Port Based	28
5.1.6	SNMP Configuration	29
5.1.6.1	SNMP – Agent Setting	29
5.1.6.2	SNMP –Trap Setting	29
5.1.6.3	SNMP – SNMP-V3 Setting.....	31
5.1.7	System Warning	33
5.1.7.1	Syslog Setting	33
5.1.7.2	System Event Log.....	34
5.1.7.3	SMTP Setting	34
5.1.7.4	Event Selection	36
5.1.7.5	Fault Relay Alarm.....	36
5.1.8	Save Configuration.....	37
5.1.9	Factory Default.....	37
5.1.10	System Reboot	38
Technical Specifications		39

Getting to Know Your Switch

1.1 About the IES-2050A Lite-Managed Industrial Switch

The IES-2050A switch is cost-effect and powerful industrial switch with many features. The switch can work under wide temperature and dusty environment and humid condition. The IES-2050A switch can be managed by WEB and a useful Windows Utility we called Open-Vision. Open-Vision is powerful network management software. With its friendly and powerful interface, you can easily configure multiple switches at the same time, and monitor switches' status

1.2 Software Features

- World's fastest Redundant Ethernet Ring (Recovery time < 10ms over 250 units connection)
- Supports Ring Coupling, Dual Homing over O-Ring, O-Chain and standard STP/RSTP
- Support fast recovery mode
- Easy-to-configure: Web / Windows utility
- Windows utility (Open-Vision) for network management

1.3 Hardware Features

- Wide Operating Temperature: -40 to 75°C
- Storage Temperature: -40 to 85°C
- Operating Humidity: 5% to 95%, non-condensing
- 10/100Base-T(X) Ethernet port
- Supports dual 12-48VDC power inputs
- Supports 24VDC@1A relay output

Hardware Installation

2.1 Installing Switch on DIN-Rail

Each switch has a DIN-Rail kit on rear panel. The DIN-Rail kit helps switch to fix on the DIN-Rail.

It is easy to install the switch on the DIN-Rail:

2.1.1 Mount IES-2050A on DIN-Rail

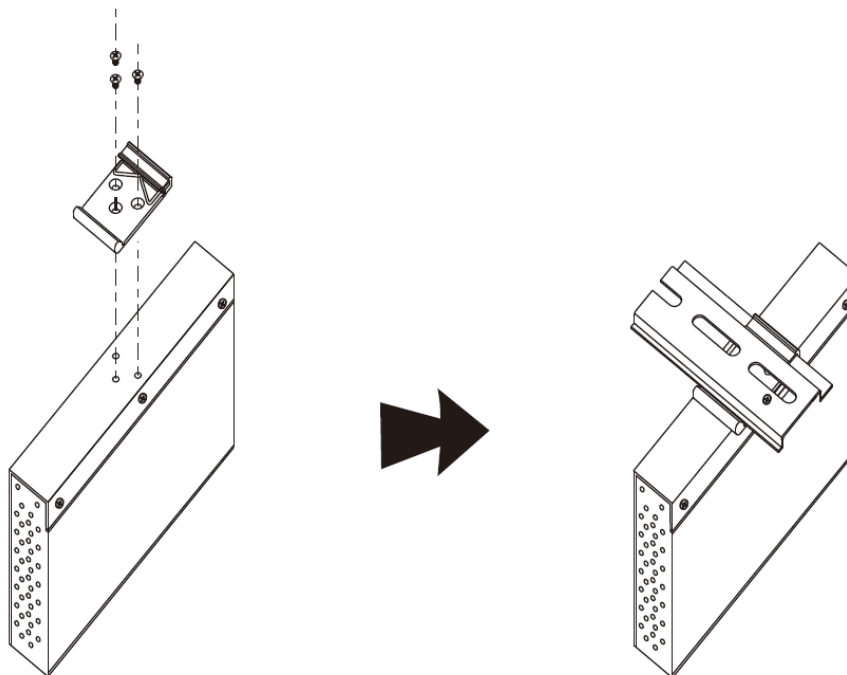

2.2 Wall Mounting Installation

Each switch has another installation method for users to fix the switch. A wall mount panel can be found in the package. The following steps show how to mount the switch on the wall:

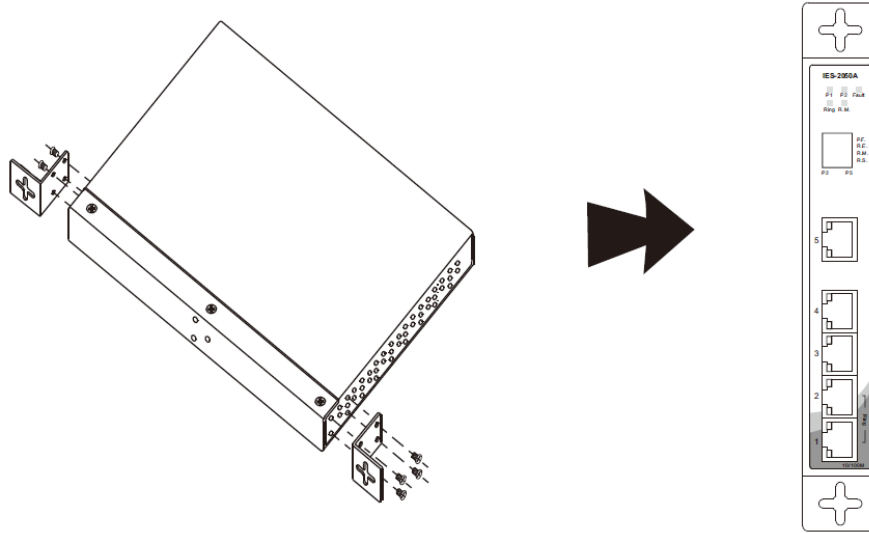

Hardware Overview

3.1 Front Panel

The following table describes the labels that stick on the IES-2050A.

Port	Description
10/100 RJ-45 fast Ethernet ports	10/100Base-T(X) RJ-45 fast Ethernet ports support auto-negotiation. Default Setting: Speed: auto Duplex: auto Flow control: disable
Reset	Push reset button 2 to 3 seconds to reset the switch. Push reset button 5 second to reset the switch into Factory Default .

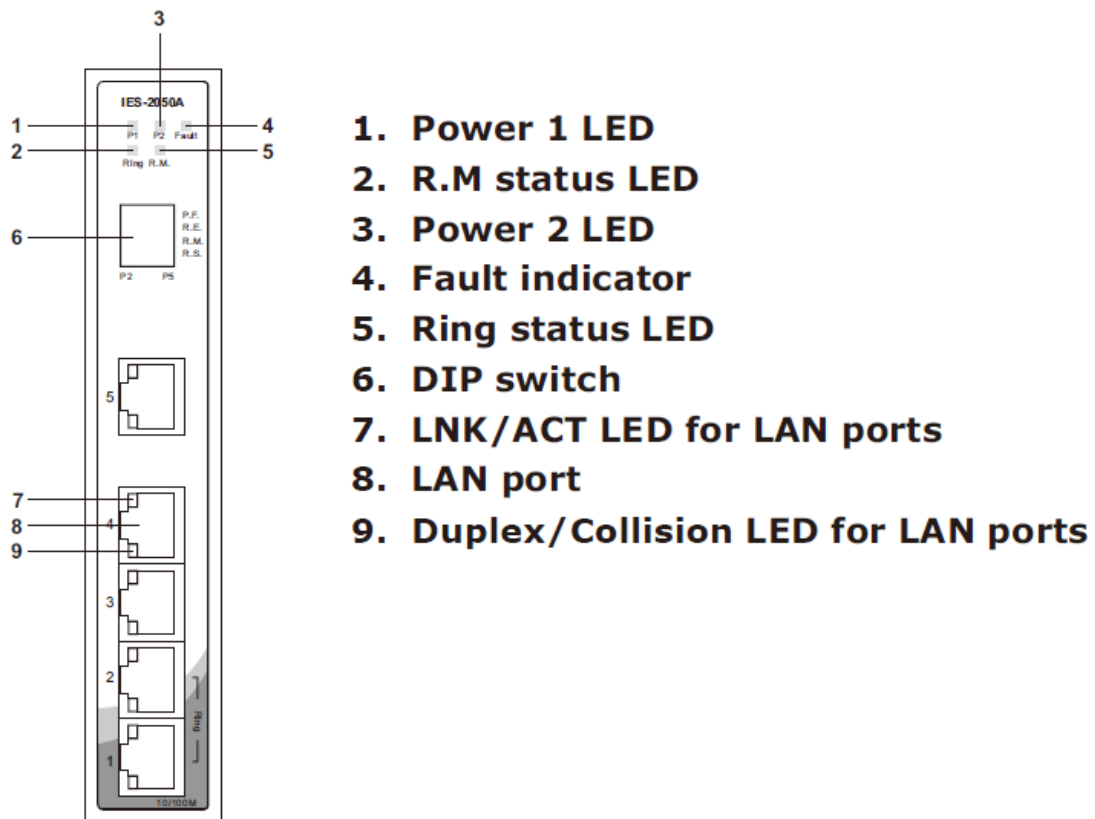

3.2 Front Panel LEDs

LED	Color	Status	Description
P1	Green	On	DC power module 1 activated.
P2	Green	On	DC power module 2 activated.
R.M	Green	On	O-Ring Master.
Ring	Green	Slowly blinking	O-Ring enabled.
			O-Ring topology has problem
		On	O-Ring work normally.
Fault	Amber	On	Fault relay. Power failure or Port down/fail.
10/100Base-T(X) Fast Ethernet ports			
LNK / ACT	Green	On	Port link up.
		Blinking	Data transmitted.
Duplex/Collision	Amber	On	Full-duplex mode
		Off	Half-duplex mode
		Blinking	Half-duplex mode and collision occurred

3.3 Bottom Panel

The bottom panel components of IES-2050A is showed as below:

Terminal block includes: PWR1, PWR2 (12-48V DC) and Relay output (1A@24VDC).

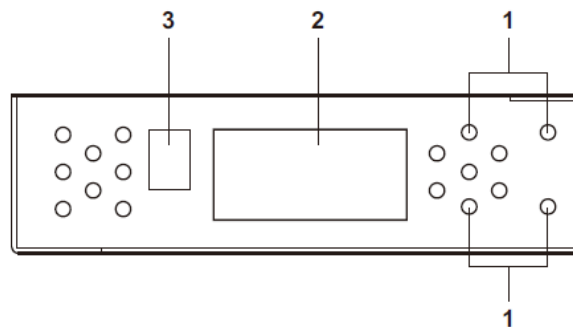

- 1. Wall-mount screw holes**
- 2. Terminal block**
- 3. DIP switch for relay output**

Cables

4.1 Ethernet Cables

The IES-2050A switch has standard Ethernet ports. According to the link type, the switch use CAT 3, 4, 5,5e UTP cables to connect to any other network device (PCs, servers, switches, routers, or hubs). Please refer to the following table for cable specifications.

Cable Types and Specifications

Cable	Type	Max. Length	Connector
10BASE-T	Cat. 3, 4, 5 100-ohm	UTP 100 m (328 ft)	RJ-45
100BASE-TX	Cat. 5 100-ohm UTP	UTP 100 m (328 ft)	RJ-45

4.1.1 100BASE-TX/10BASE-T Pin Assignments

With 100BASE-TX/10BASE-T cable, pins 1 and 2 are used for transmitting data, and pins 3 and 6 are used for receiving data.

RJ-45 Pin Assignments

Pin Number	Assignment
1	TD+
2	TD-
3	RD+
4	Not used
5	Not used
6	RD-
7	Not used
8	Not used

The IES-2050A switch support auto MDI/MDI-X operation. You can use a straight-through cable to connect PC and switch. The following table below shows the 10BASE-T/ 100BASE-TX MDI and MDI-X port pin outs.

MDI/MDI-X pins assignment

Pin Number	MDI port	MDI-X port
1	TD+(transmit)	RD+(receive)
2	TD-(transmit)	RD-(receive)
3	RD+(receive)	TD+(transmit)
4	Not used	Not used
5	Not used	Not used
6	RD-(receive)	TD-(transmit)
7	Not used	Not used
8	Not used	Not used

Note: "+" and "-" signs represent the polarity of the wires that make up each wire pair.

WEB Management



5.1 Configuration by Web Browser

This section introduces the configuration by Web browser.

5.1.1 About Web-based Management

An embedded HTML web site resides in flash memory on the CPU board. It contains advanced management features and allows you to manage the switch from anywhere on the network through a standard web browser such as Microsoft Internet Explorer.

The Web-Based Management function supports Internet Explorer 5.0 or later. It is based on Java Applets with an aim to reduce network bandwidth consumption, enhance access speed and present an easy viewing screen.

Note: By default, IE5.0 or later version does not allow Java Applets to open sockets. You need to explicitly modify the browser setting in order to enable Java Applets to use network ports.

Preparing for Web Management

The default value is as below:

IP Address: **192.168.10.1**

Subnet Mask: **255.255.255.0**

Default Gateway: **192.168.10.254**

User Name: **admin**

Password: **admin**

System Login

1. Launch the Internet Explorer.
2. Type http:// and the IP address of the switch. Press "**Enter**".



3. The login screen appears.
4. Key in the username and password. The default username and password is “admin”.
5. Click “Enter” or “OK” button, then the main interface of the Web-based management appears.

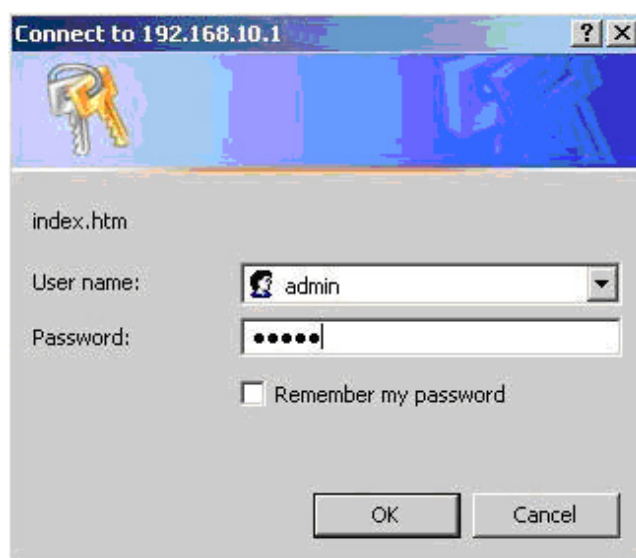

Login screen

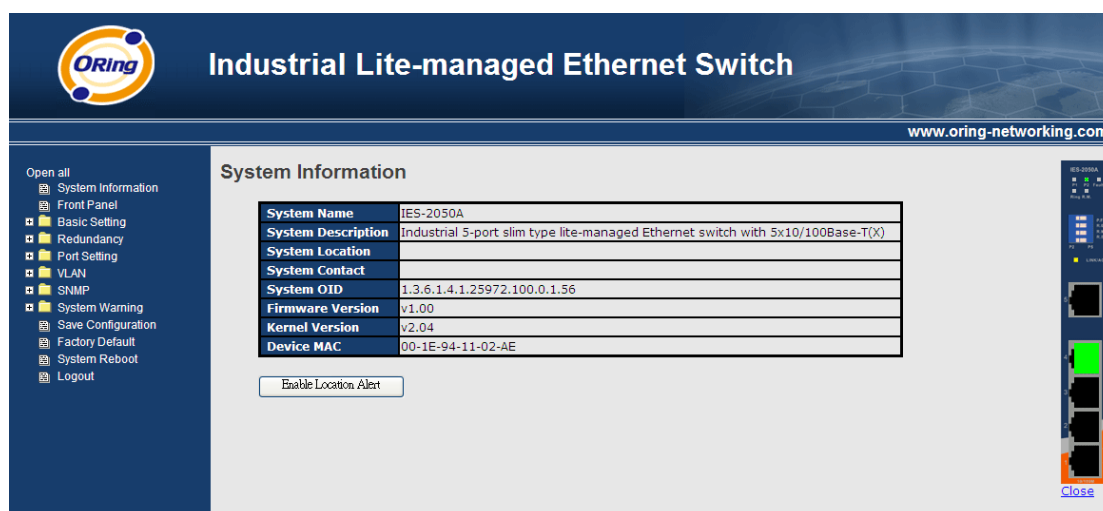

Main interface

5.1.2 Basic Setting

5.1.2.1 Switch setting

Switch Setting

System Name	IES-2050A
System Description	Industrial 5-port slim type lite-managed Ethernet switch with 5x10/100Base-T(X)
System Location	
System Contact	

Switch setting interface

The following table describes the labels in this screen.

Label	Description
System Name	Assign the name of switch. The maximum length is 64 bytes
System Description	Display the description of switch.
System Location	Assign the switch physical location. The maximum length is 64 bytes
System Contact	Enter the name of contact person or organization
Firmware Version	Display the switch's firmware version
Kernel Version	Display the kernel software version
MAC Address	Display the unique hardware address assigned by manufacturer (default)

5.1.2.2 Admin Password

Change web management login username and password for the management security issue

Admin Password

User Name	admin
New Password	
Confirm Password	

Admin Password interface

The following table describes the labels in this screen.

Label	Description
User name	Key in the new username (The default is “admin”)
New Password	Key in the new password (The default is “admin”)
Confirm password	Re-type the new password.
Apply	Click “Apply” to activate the configurations.

5.1.2.3 IP configuration

You can configure the IP Settings and DHCP client function through IP configuration.

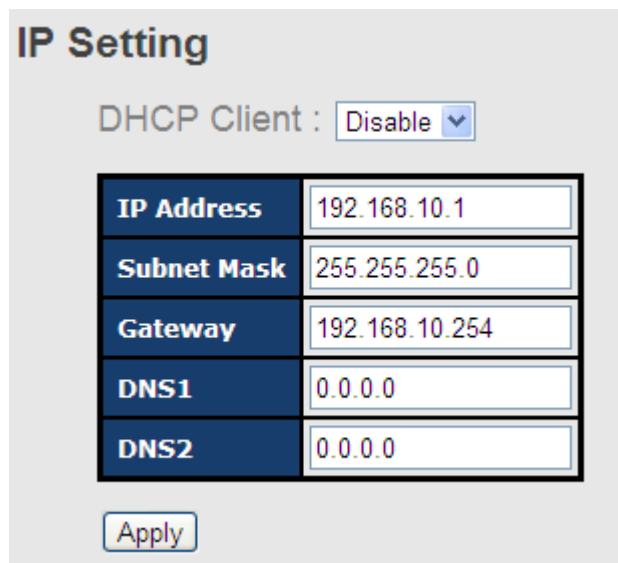

IP Configuration interface

The following table describes the labels in this screen.

Label	Description
DHCP Client	To enable or disable the DHCP client function. When DHCP client function is enabling, the switch will assign the IP address from the network DHCP server. The default IP address will be replaced by the IP address which the DHCP server has assigned. After clicking “Apply” button, a popup dialog will show up to inform you when the DHCP client is enabling. The current IP will lose and you should find the new IP on the DHCP server.
IP Address	Assign the IP address that the network is using. If DHCP client function is enabling, you do not need to assign the IP address. The network DHCP server will assign the IP address for the switch and it will be displayed in this column. The default IP is 192.168.10.1
Subnet Mask	Assign the subnet mask for the IP address. If DHCP client function is

	enabling, you do not need to assign the subnet mask.
Gateway	Assign the network gateway for the switch. The default gateway is 192.168.10.254
DNS1	Assign the primary DNS IP address
DNS2	Assign the secondary DNS IP address
Apply	Click “Apply” to activate the configurations.

5.1.2.4 SNTP Configuration

The SNTP (Simple Network Time Protocol) settings allow you to synchronize switch clocks in the Internet.

SNTP (Time)

SNTP Client : ▾

Daylight Saving Time : ▾

UTC Timezone	<input type="text" value="(GMT)Greenwich Mean Time: Dublin, Edinburgh, Lisbon, London"/> ▾
SNTP Server IP Address	<input type="text" value="192.168.10.66"/>
Current System Time	N/A
Daylight Saving Period	2006 ▾ / Jan ▾ / 2 ▾ 00 ▾ ~ 2006 ▾ / Jan ▾ / 2 ▾ 00 ▾
Daylight Saving Offset	<input type="text" value="0"/> (hours)

SNTP Configuration interface

The following table describes the labels in this screen.

Label	Description	
SNTP Client	Enable or disable SNTP function to get the time from the SNTP server.	
Daylight Saving Time	Enable or disable daylight saving time function. When daylight saving time is enabling, you need to configure the daylight saving time period.	
UTC Time zone	Set the switch location time zone. The following table lists the different location time zone for your reference.	
Local Time Zone	Conversion from UTC	Time at 12:00 UTC
November Time Zone	- 1 hour	11 am

Oscar Time Zone	-2 hours	10 am
ADT - Atlantic Daylight	-3 hours	9 am
AST - Atlantic Standard EDT - Eastern Daylight	-4 hours	8 am
EST - Eastern Standard CDT - Central Daylight	-5 hours	7 am
CST - Central Standard MDT - Mountain Daylight	-6 hours	6 am
MST - Mountain Standard PDT - Pacific Daylight	-7 hours	5 am
PST - Pacific Standard ADT - Alaskan Daylight	-8 hours	4 am
ALA - Alaskan Standard	-9 hours	3 am
HAW - Hawaiian Standard	-10 hours	2 am
Nome, Alaska	-11 hours	1 am
CET - Central European FWT - French Winter MET - Middle European MEWT - Middle European Winter SWT - Swedish Winter	+1 hour	1 pm
EET - Eastern European, USSR Zone 1	+2 hours	2 pm
BT - Baghdad, USSR Zone 2	+3 hours	3 pm
ZP4 - USSR Zone 3	+4 hours	4 pm
ZP5 - USSR Zone 4	+5 hours	5 pm
ZP6 - USSR Zone 5	+6 hours	6 pm
WAST - West Australian Standard	+7 hours	7 pm
CCT - China Coast, USSR Zone 7	+8 hours	8 pm
JST - Japan Standard, USSR Zone 8	+9 hours	9 pm

EAST - East Australian Standard GST Guam Standard, USSR Zone 9	+10 hours	10 pm
IDLE - International Date Line NZST - New Zealand Standard NZT - New Zealand	+12 hours	Midnight

The following table describes the labels in this screen.

Label	Description
SNTP Sever IP Address	Set the SNTP server IP address.
Daylight Saving Period	Set up the Daylight Saving beginning time and Daylight Saving ending time. Both will be different each year.
Daylight Saving Offset	Set up the offset time.
Switch Timer	Display the switch current time.
Apply	Click " Apply " to activate the configurations.

5.1.2.5 LLDP

LLDP (Link Layer Discovery Protocol) function allows the switch to advertise its information to other nodes on the network and store the information it discovers.

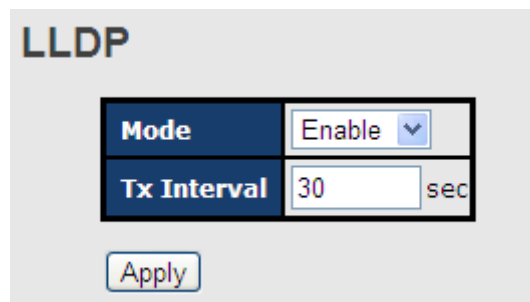

LLDP interface

The following table describes the labels in this screen.

Label	Description
LLDP Protocol	"Enable" or "Disable" LLDP function.
LLDP Interval	The interval of resend LLDP (by default at 30 seconds)
Apply	Click " Apply " to activate the configurations.
Help	Show help file.

5.1.2.6 Dip Setting

You can select Dip switch mode enable or disable

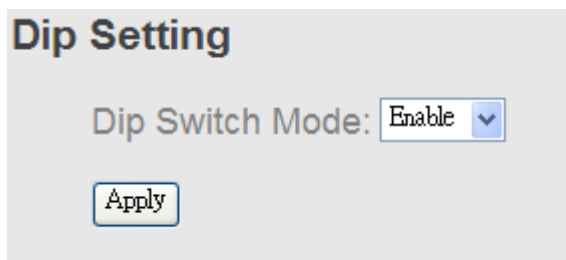

Dip setting interface

The following table describes the labels in this screen

Label	Description
Dip Switch Mode	Enable or disable Dip Switch control
Apply	Apply setting

5.1.2.7 Backup & Restore

You can save current EEPROM value of the switch to TFTP server, then go to the TFTP restore configuration page to restore the EEPROM value.

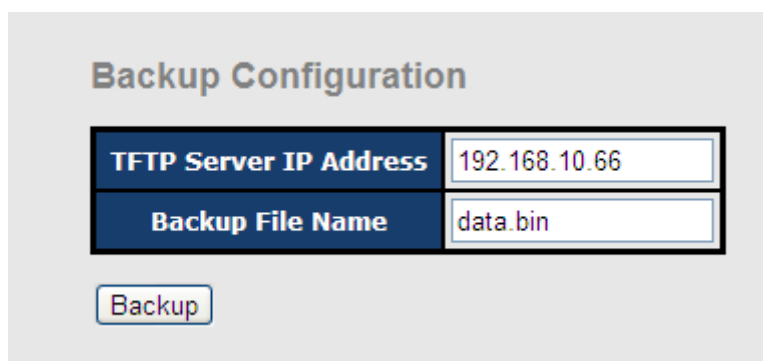
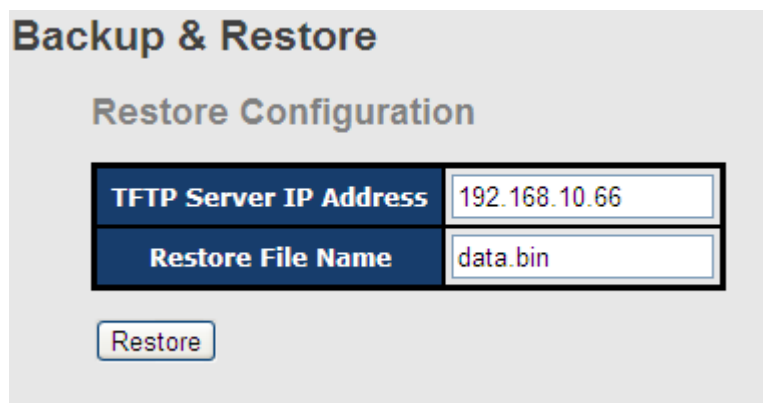

Backup & Restore interface

The following table describes the labels in this screen.

Label	Description
TFTP Server IP Address	Fill in the TFTP server IP
Restore File Name	Fill the file name.
Restore	Click “ restore ” to restore the configurations.
Restore File Name	Fill the file name.
Restore	Click “ restore ” to restore the configurations.
Backup	Click “ backup ” to backup the configurations.

5.1.2.8 Upgrade Firmware

Upgrade Firmware allows you to update the switch firmware. Before updating, make sure you have your TFTP server ready and the firmware image is on the TFTP server.

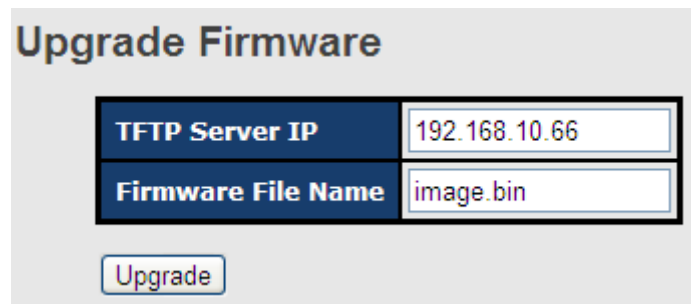

Update Firmware interface

5.1.3 Redundancy

5.1.3.1 Fast Recovery Mode

The Fast Recovery Mode can be set to connect multiple ports to one or more switches. The IES-2050A with its fast recovery mode will provide redundant links. Fast Recovery mode supports 5 priorities, only the first priority will be the act port, the other ports configured with other priority will be the backup ports.



Fast Recovery Mode interface

The following table describes the labels in this screen.

Label	Description
Active	Activate the fast recovery mode.
port	Port can be configured as 5 priorities. Only the port with highest priority will be the active port. 1st Priority is the highest.
Apply	Click " Apply " to activate the configurations.

5.1.3.2 O-Ring

O-Ring is one of the most powerful Redundant Ring technologies in the world. The recovery time of O-Ring is less than 10ms over 250 units of connections. It can reduce unexpected malfunction caused by network topology change. O-Ring technology supports three Ring topologies for network redundancy: O-Ring, Coupling Ring and Dual Homing.

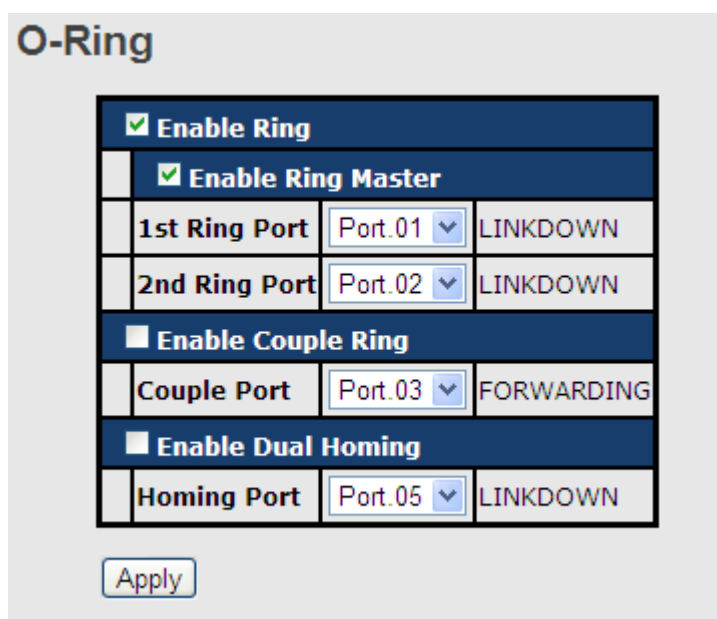

O-Ring interface

The following table describes the labels in this screen.

Label	Description
O-Ring	Mark to enable O-Ring.
Ring Master	There should be one and only one Ring Master in a ring. However, if there are two or more switches which set Ring Master to enable, the switch with the lowest MAC address will be the actual Ring Master and others will be Backup Masters.
1st Ring Port	The primary port
2nd Ring Port	The backup port
Coupling Ring	Mark to enable Coupling Ring. Coupling Ring can be used to divide a big ring into two smaller rings to avoid effecting all switches when network topology change. It is a good application for connecting two O-Rings.
Coupling Port	Link to Coupling Port of the switch in another ring. Coupling Ring need four switches to build an active and a backup link. Set a port as coupling port. The coupled four ports of four switches will be run at active/backup mode.
Control Port	Link to Control Port of the switch of the same ring. Control Port used to transmit control signals.
Dual Homing	Mark to enable Dual Homing. By selecting Dual Homing mode, O-Ring will be connected to normal switches through two RSTP links (ex: backbone Switch). The two links work as active/backup mode,

	and connect each O-Ring to the normal switches in RSTP mode.
Apply	Click “ Apply ” to activate the configurations.

Note: We don't suggest you to set one switch as a Ring Master and a Coupling Ring at the same time due to heavy load.

5.1.3.3 O-Chain

O-Chain is the revolutionary network redundancy technology that provides the add-on network redundancy topology for any backbone network, providing ease-of-use while maximizing fault-recovery swiftness, flexibility, compatibility, and cost-effectiveness in one set of network redundancy topology. O-Chain allows multiple redundant network rings of different redundancy protocols to join and function together as a larger and more robust compound network topology, i.e. the creation of multiple redundant networks beyond the limitations of current redundant ring technology.

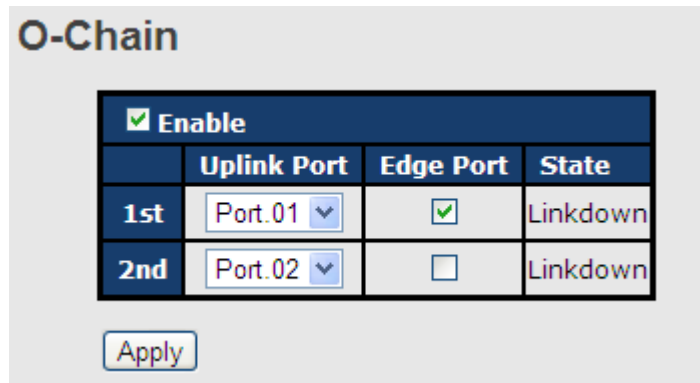

O-Chain interface

Label	Description
Enable	Enabling the O-Chain function
1st Ring Port	Choosing the port which connect to the ring
2nd Ring Port	Choosing the port which connect to the ring
Edge Port	In the O-Chain application, the head and tail of two Switch Port, must start the Edge, MAC smaller Switch, Edge port will be the backup and RM LED Light.

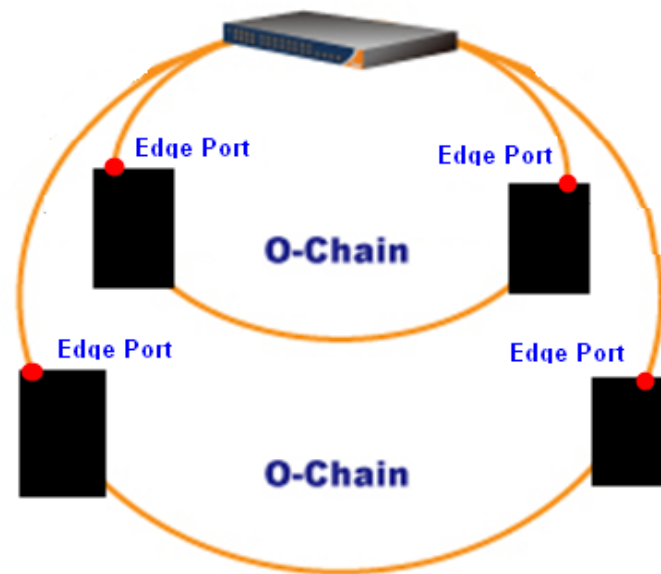

5.1.3.4 RSTP

The Rapid Spanning Tree Protocol (RSTP) is an evolution of the Spanning Tree Protocol. It provides faster spanning tree convergence after a topology change. The system also supports STP and the system will auto detect the connected device that is running STP or RSTP protocol.

RSTP setting

You can enable/disable the RSTP function, and set the parameters for each port.

RSTP - Setting

RSTP Mode :

Bridge Configuration

Priority (0-61440)	<input type="text" value="32768"/>
Max Age Time(6-40)	<input type="text" value="20"/>
Hello Time (1-10)	<input type="text" value="2"/>
Forward Delay Time (4-30)	<input type="text" value="15"/>

Port Configuration

Port	Path Cost (1-200000000)	Priority (0-240)	Admin P2P	Admin Edge	Admin Non STP
1	<input type="text" value="200000"/>	<input type="text" value="128"/>	<input type="text" value="Auto"/>	<input type="text" value="True"/>	<input type="text" value="False"/>
2	<input type="text" value="200000"/>	<input type="text" value="128"/>	<input type="text" value="Auto"/>	<input type="text" value="True"/>	<input type="text" value="False"/>
3	<input type="text" value="200000"/>	<input type="text" value="128"/>	<input type="text" value="Auto"/>	<input type="text" value="True"/>	<input type="text" value="False"/>
4	<input type="text" value="200000"/>	<input type="text" value="128"/>	<input type="text" value="Auto"/>	<input type="text" value="True"/>	<input type="text" value="False"/>
5	<input type="text" value="200000"/>	<input type="text" value="128"/>	<input type="text" value="Auto"/>	<input type="text" value="True"/>	<input type="text" value="False"/>
6	<input type="text" value="200000"/>	<input type="text" value="128"/>	<input type="text" value="Auto"/>	<input type="text" value="True"/>	<input type="text" value="False"/>

RSTP Setting interface

The following table describes the labels in this screen.

Label	Description
RSTP mode	You must enable or disable RSTP function before configuring the related parameters.
Priority (0-61440)	A value used to identify the root bridge. The bridge with the lowest value has the highest priority and is selected as the root. If the value changes, you must reboot the switch. The value must be multiple of 4096 according to the protocol standard rule.
Max Age (6-40)	The number of seconds a bridge waits without receiving Spanning-tree Protocol configuration messages before attempting a reconfiguration. Enter a value between 6 through 40.
Hello Time (1-10)	The time that controls switch sends out the BPDU packet to check RSTP

	current status. Enter a value between 1 through 10.
Forwarding Delay Time (4-30)	The number of seconds a port waits before changing from its Rapid Spanning-Tree Protocol learning and listening states to the forwarding state. Enter a value between 4 through 30.
Path Cost (1-200000000)	The cost of the path to the other bridge from this transmitting bridge at the specified port. Enter a number 1 through 200000000.
Priority (0-240)	Decide which port should be blocked by priority in LAN. Enter a number 0 through 240. The value of priority must be the multiple of 16
Admin P2P	Some of the rapid state transactions that are possible within RSTP are dependent upon whether the port concerned can only be connected to exactly one other bridge (i.e. It is served by a point-to-point LAN segment), or it can be connected to two or more bridges (i.e. It is served by a shared medium LAN segment). This function allows the P2P status of the link to be manipulated administratively. True means P2P enabling. False means P2P disabling.
Admin Edge	The port is directly connected to end stations, and it cannot create bridging loop in the network. To configure the port as an edge port, set the port to “True” .
Admin Non STP	The port includes the STP mathematic calculation. True is not including STP mathematic calculation. False is including the STP mathematic calculation.
Apply	Click “Apply” to activate the configurations.

NOTE: Follow the rule to configure the MAX Age, Hello Time, and Forward Delay Time:

$$2 \times (\text{Forward Delay Time value} - 1) \geq \text{Max Age value} \geq 2 \times (\text{Hello Time value} + 1)$$

RSTP Information

Show RSTP algorithm result at this table.

RSTP - Information

Root Bridge Information

Bridge ID	8000-001E94170067
Root Priority	32768
Root Port	Root
Root Path Cost	0
Max Age Time	20
Hello Time	2
Forward Delay Time	15

Port Information

Port	Path Cost	Port Priority	OperP2P	OperEdge	STP Neighbor	State	Role
Port.01	200000	128	True	True	False	Disabled	Disabled
Port.02	200000	128	True	True	False	Disabled	Disabled
Port.03	200000	128	True	True	False	Forwarding	Designated
Port.04	200000	128	True	True	False	Disabled	Disabled
Port.05	200000	128	True	True	False	Disabled	Disabled
Port.06	200000	128	True	True	False	Disabled	Disabled

RSTP Information interface

5.1.4 Port Configuration

5.1.4.1 Port Control

By this function, you can set the state, speed/duplex, flow control, and security of the port.

Port Control

Port No.	State	Speed/Duplex	Flow Control
Port.01	Enable	AutoNegotiation	Disable
Port.02	Enable	AutoNegotiation	Disable
Port.03	Enable	AutoNegotiation	Disable
Port.04	Enable	AutoNegotiation	Disable
Port.05	Enable	100 Full	Disable
Port.06	Enable	100 Full	Disable

Apply

Port Control interface

The following table describes the labels in this screen.

Label	Description
Port NO.	Port number for setting.
State	Enable/Disable the port.
Speed/Duplex	You can set Auto-negotiation, 100 full,100 half,10 full,10 half mode.
Flow Control	Support symmetric and asymmetric mode to avoid packet loss when congestion occurred.
Apply	Click “Apply” to activate the configurations.

5.1.4.2 Port Status

The following information provides the current port status.

Port Status

Port No.	Type	Link	State	Speed/Duplex	Flow Control
Port.01	100TX	Down	Enable	N/A	N/A
Port.02	100TX	Down	Enable	N/A	N/A
Port.03	100TX	UP	Enable	100 Full	Disable
Port.04	100TX	Down	Enable	N/A	N/A
Port.05	100SFP	Down	Enable	N/A	N/A
Port.06	100SFP	Down	Enable	N/A	N/A

Port Status interface

5.1.4.3 Port Alias

The user can define the name of every Port. User can be convenient management every Port.

Port Alias

Port No.	Port Alias
Port.01	test port
Port.02	monitor port
Port.03	
Port.04	
Port.05	
Port.06	

5.1.5 VLAN

A Virtual LAN (VLAN) is a logical network grouping that limits the broadcast domain, which allows you to isolate network traffic. Only the members of the VLAN will receive traffic from the same members of VLAN. Basically, creating a VLAN from a switch is logically equivalent of reconnecting a group of network devices to another Layer 2 switch. However, all the network devices are still plugged into the same switch physically.

The switch supports port-based VLAN only.

5.1.5.1 VLAN Configuration – Port Based

Traffic is forwarded to the member ports of the same vlan group. vlan port based startup, set in the same group of the port, can be a normal transmission packet, without restricting the types of packets.

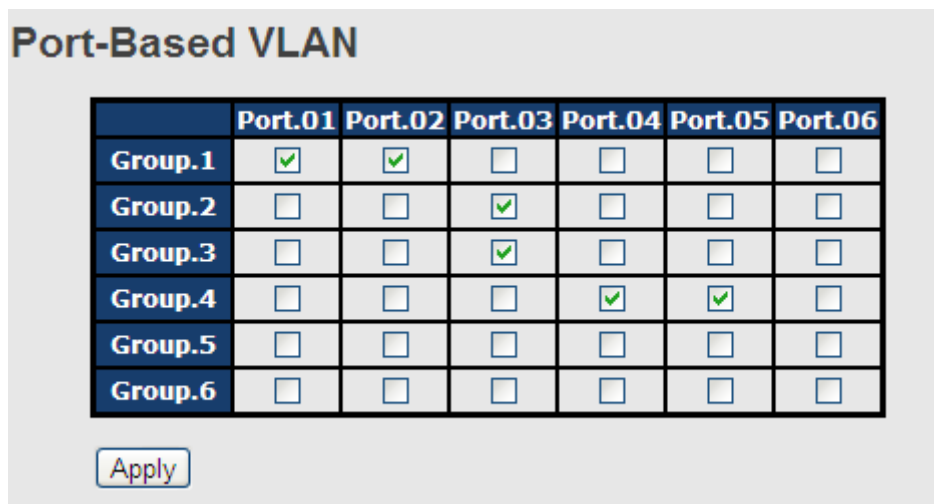

VLAN Configuration – Port Based VLAN interface

The following table describes the labels in this screen.

Label	Description
Group	Mark the blank to assign the port into VLAN group.
Apply	Click “ Apply ” to activate the configurations.
Help	Show help file.

5.1.6 SNMP Configuration

Simple Network Management Protocol (SNMP) is the protocol developed to manage nodes (servers, workstations, routers, switches and hubs etc.) on an IP network. SNMP enables network administrators to manage network performance, find and solve network problems, and plan for network growth. Network management systems learn of problems by receiving traps or change notices from network devices implementing SNMP.

5.1.6.1 SNMP – Agent Setting

You can set SNMP agent related information by Agent Setting Function.

SNMP – Agent Setting interface

The following table describes the labels in this screen.

Label	Description
SNMP – Agent Setting	SNMP Community should be set for SNMP. Four sets of "Community String/Privilege" are supported. Each Community String is maximum 32 characters. Keep empty to remove this Community string.

5.1.6.2 SNMP –Trap Setting

A trap manager is a management station that receives traps, the system alerts generated by the switch. If no trap manager is defined, no traps will issue. Create a trap manager by entering the IP address of the station and a community string. To define management stations as trap manager and enter SNMP community strings and selects the SNMP version.

SNMP –Trap Setting interface

The following table describes the labels in this screen.

Label	Description
Server IP	The server IP address to receive Trap
Community	Community for authentication
Trap Version	Trap Version supports V1 and V2c.
Add	Add trap server profile.
Remove	Remove trap server profile.
Help	Show help file.

5.1.6.3 SNMP – SNMP-V3 Setting

SNMP - SNMPv3 Setting

SNMPv3 Engine ID: f465000003001e94170067

Context Table

Context Name :	<input type="text"/>	<input type="button" value="Apply"/>
----------------	----------------------	--------------------------------------

User Table

Current User Profiles : <input type="button" value="Remove"/>	New User Profile : <input type="button" value="Add"/>
<input type="text" value="(none)"/>	User ID: <input type="text"/>
	Authentication Password: <input type="text"/>
	Privacy Password: <input type="text"/>

Group Table

Current Group content : <input type="button" value="Remove"/>	New Group Table: <input type="button" value="Add"/>
<input type="text" value="(none)"/>	Security Name (User ID): <input type="text"/>
	Group Name: <input type="text"/>

Access Table

Current Access Tables : <input type="button" value="Remove"/>	New Access Table : <input type="button" value="Add"/>
<input type="text" value="(none)"/>	Context Prefix: <input type="text"/>
	Group Name: <input type="text"/>
	Security Level: <input type="radio"/> NoAuthNoPriv. <input type="radio"/> AuthNoPriv. <input type="radio"/> AuthPriv.
	Context Match Rule <input type="radio"/> Exact <input type="radio"/> Prefix
	Read View Name: <input type="text"/>
	Write View Name: <input type="text"/>
	Notify View Name: <input type="text"/>

MIBView Table

Current MIBTables : <input type="button" value="Remove"/>	New MIBView Table : <input type="button" value="Add"/>
<input type="text" value="(none)"/>	View Name: <input type="text"/>
	SubOid-Tree: <input type="text"/>
	Type: <input type="radio"/> Excluded <input type="radio"/> Included

The following table describes the labels in this screen

Label	Description
Context Table	Configure SNMP v3 context table. Assign the context name of context table. Click "Apply" to change context name
User Table	<ol style="list-style-type: none"> 1. Configure SNMP v3 user table. 2. User ID: set up the user name. 3. Authentication Password: set up the authentication password. 4. Privacy Password: set up the private password. 5. Click "Add" to add context name. 6. Click "Remove" to remove unwanted context name.
Group Table	<ol style="list-style-type: none"> 1. Configure SNMP v3 group table. 2. Security Name (User ID): assign the user name that you have set up in user table. 3. Group Name: set up the group name. 4. Click "Add" to add context name. 5. Click "Remove" to remove unwanted context name.
Access Table	<ol style="list-style-type: none"> 1. Configure SNMP v3 access table. 2. Context Prefix: set up the context name. 3. Group Name: set up the group. 4. Security Level: select the access level. 5. Context Match Rule: select the context match rule. 6. Read View Name: set up the read view. 7. Write View Name: set up the write view. 8. Notify View Name: set up the notify view. 9. Click "Add" to add context name. 10. Click "Remove" to remove unwanted context name.
MIBview Table	<ol style="list-style-type: none"> 1. Configure MIB view table. 2. ViewName: set up the name. 3. Sub-Oid Tree: fill the Sub OID. 4. Type: select the type – exclude or included. 5. Click "Add" to add context name. 6. Click "Remove" to remove unwanted context name.
Help	Show help file.

5.1.7 System Warning

Warning function is very important for managing switch. You can manage switch by SYSLOG, E-MAIL, and Fault Relay. It helps you to monitor the switch status on remote site. When events occurred, the warning message will send to your appointed server, E-MAIL, or relay fault to switch panel.

5.1.7.1 Syslog Setting

The SYSLOG is a protocol to transmit event notification messages across networks. Please refer to RFC 3164 - The BSD SYSLOG Protocol

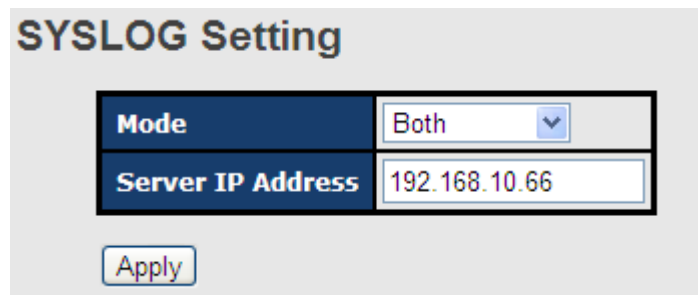

System Warning – SYSLOG Setting interface

The following table describes the labels in this screen.

Label	Description
SYSLOG Mode	<ul style="list-style-type: none"> ■ Disable: disable SYSLOG. ■ Client Only: log to local system. ■ Server Only: log to a remote SYSLOG server. ■ Both: log to both of local and remote server.
SYSLOG Server IP Address	The remote SYSLOG Server IP address.
Apply	Click " Apply " to activate the configurations.
Help	Show help file.

5.1.7.2 System Event Log

If system log client is enabled, the system event logs will show in this table.

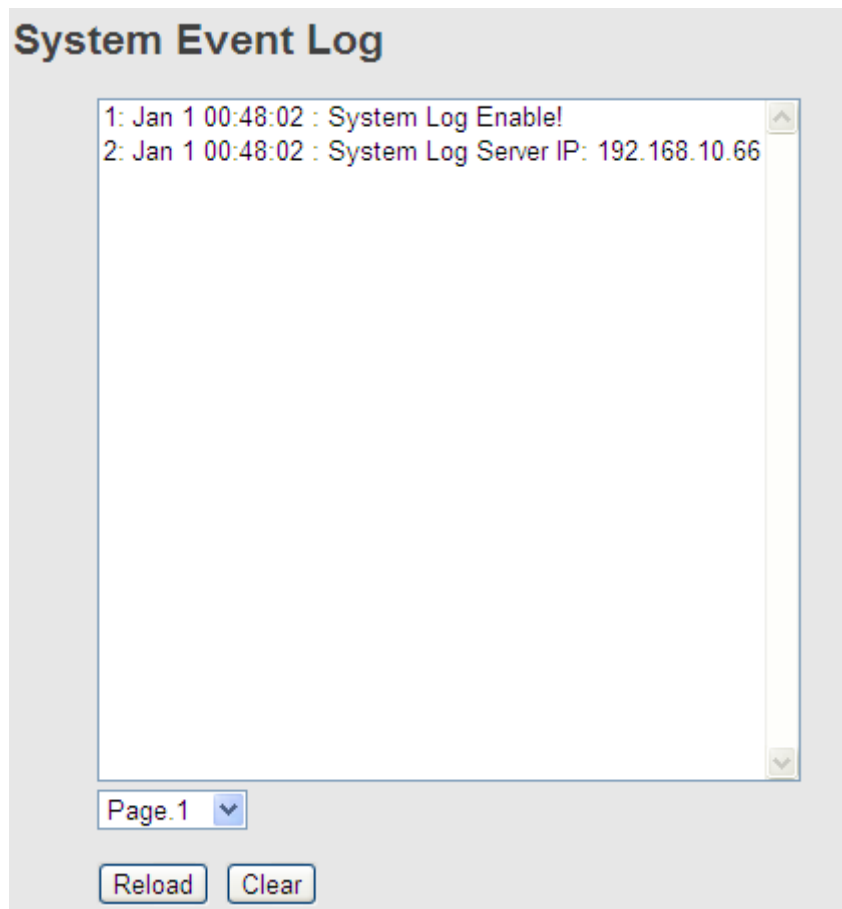

System event log interface

The following table describes the labels in this screen.

Label	Description
Page	Select LOG page.
Reload	To get the newest event logs and refresh this page.
Clear	Clear log.
Help	Show help file.

5.1.7.3 SMTP Setting

The SMTP is Short for Simple Mail Transfer Protocol. It is a protocol for e-mail transmission across the Internet. Please refer to RFC 821 - Simple Mail Transfer Protocol.

SMTP Setting

E-mail Alert : ▾

SMTP Configuration

SMTP Server IP Address	<input type="text" value="192.168.10.66"/>
Sender E-mail Address	<input type="text" value="admin"/>
Mail Subject	<input type="text" value="Automated Email Alert"/>
<input type="checkbox"/> Authentication	
Recipient E-mail Address 1	<input type="text" value="test@192.168.10.66"/>
Recipient E-mail Address 2	<input type="text"/>
Recipient E-mail Address 3	<input type="text"/>
Recipient E-mail Address 4	<input type="text"/>

System Warning – SMTP Setting interface

The following table describes the labels in this screen.

Label	Description
E-mail Alarm	Enable/Disable transmission system warning events by e-mail.
Sender E-mail Address	The SMTP server IP address
Mail Subject	The Subject of the mail
Authentication	<ul style="list-style-type: none"> ■ Username: the authentication username. ■ Password: the authentication password. ■ Confirm Password: re-enter password.
Recipient E-mail Address	The recipient's E-mail address. It supports up to 6 recipients per mail.
Apply	Click “ Apply ” to activate the configurations.
Help	Show help file.

5.1.7.4 Event Selection

SYSLOG and SMTP are the two warning methods that supported by the system. Check the corresponding box to enable system event warning method you wish to choose. Please note that the checkbox cannot be checked when SYSLOG or SMTP is disabled.

Event Selection

System Event

Event	SYSLOG	SMTP
System Restart	<input type="checkbox"/>	<input checked="" type="checkbox"/>
O-Ring Topology Change	<input checked="" type="checkbox"/>	<input type="checkbox"/>

Port Event

Port No.	SYSLOG	SMTP
Port.01	Link Up & Link Down ▾	Disable ▾
Port.02	Disable ▾	Disable ▾
Port.03	Link Up & Link Down ▾	Disable ▾
Port.04	Disable ▾	Link Up & Link Down ▾
Port.05	Disable ▾	Disable ▾
Port.06	Disable ▾	Link Up & Link Down ▾

System Warning – Event Selection interface

The following table describes the labels in this screen.

Label	Description
System Event	
System Cold Start	Alert when system restart
O-Ring Topology Change	Alert when O-Ring topology change
Port Event	<ul style="list-style-type: none"> ■ Disable ■ Link Up ■ Link Down ■ Link Up & Link Down
Apply	Click “ Apply ” to activate the configurations.
Help	Show help file.

5.1.7.5 Fault Relay Alarm

When any selected fault event is happened, the Fault LED in switch panel will light up and the

electric relay will signal at the same time.

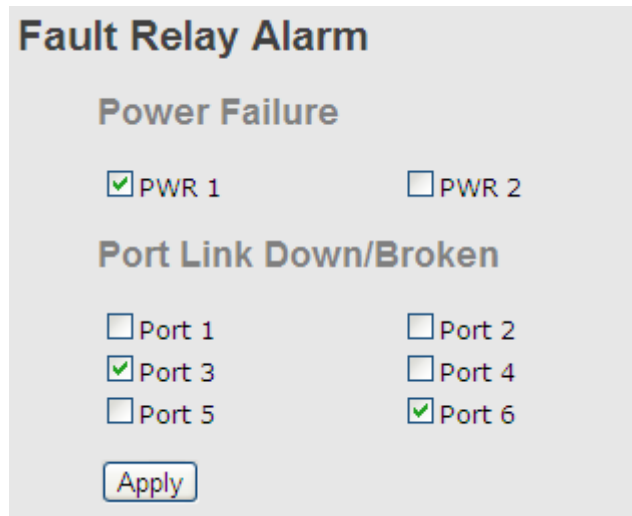

Fault alarm interface

5.1.8 Save Configuration

If any configuration changed, “**Save Configuration**” should be clicked to save current configuration data into the permanent flash memory. Otherwise, the current configuration will be lost when power off or system reset.

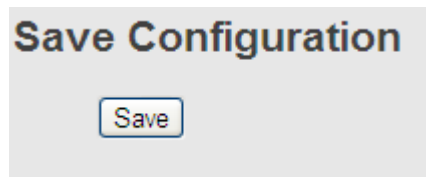

System Configuration interface

The following table describes the labels in this screen.

Label	Description
Save	Save all configurations.
Help	Show help file.

5.1.9 Factory Default

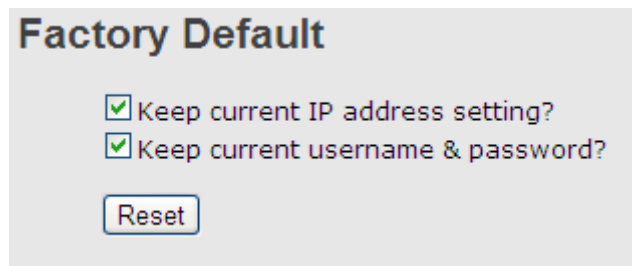

Factory Default interface

Reset switch to default configuration. Click to reset all configurations to the default value. You can select “**Keep current IP address setting**” and “**Keep current username & password**” to prevent IP and username & password from default.

5.1.10 System Reboot

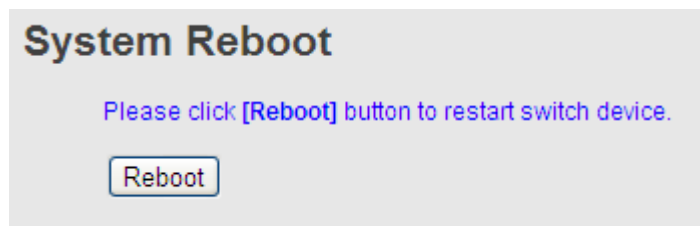

System Reboot interface

Technical Specifications

ORing Switch Model	IES-2050A
Physical Ports	
10/100Base-T(X) Ports in RJ45 Auto MDI/MDIX	5
Technology	
Ethernet Standards	IEEE 802.3 for 10Base-T IEEE 802.3u for 100Base-TX IEEE 802.3x for Flow control IEEE 802.1D for STP (Spanning Tree Protocol) IEEE 802.1w for RSTP (Rapid Spanning Tree Protocol) IEEE 802.1AB for LLDP (Link Layer Discovery Protocol)
MAC Table	2K
Packet Buffer Size	1Mbits
Priority Queues	4
Processing	Store-and-Forward
Switch Properties	Switching latency: 8.94 μ s Switching bandwidth: 1Gbps Throughput (packet per second): 744Kpps@64Bytes packet VLAN: Port based
Security Features	Enable/disable ports VLAN to segregate and secure network traffic
Software Features	STP/RSTP (IEEE 802.1D/w) Redundant Ring (O-Ring) with recovery time less than 10ms over 250 units DHCP Client Port Base VLAN LLDP (Link Layer Discovery Protocol) Port configuration, status, statistics, monitoring, security SNMP v1/v2c/v3 and private MIB support
Network Redundancy	O-Ring O-Chain Fast recovery RSTP/STP
DIP-Switch Setting	
P.F.	When power fault enables relay warning system (On: Enable, Off: Disable function)
R.E.	Enable/Disable O-Ring function (On: Enable, Off: Disable)
R.M.	Enable/Disable Ring Master Mode (On: Enable, Off: Disable)
R.S.	O-Ring redundant port select (On: ring port set to port-1 and port-5, Off: ring port set to port-1 and port-2)
LED Indicators	
Power Indicator (PWR)	Green: Power LED x 2
Ring Master Indicator (R.M.)	Green: Indicates that the system is operating in O-Ring Master mode
O-Ring Indicator (Ring)	Green: Indicates that the system operating in O-Ring mode Green Blinking: Indicates that the Ring is broken.
Fault Indicator (Fault)	Amber: Indicate unexpected event occurred
10/100Base-T(X) RJ45 Port Indicator	Green for Link/Act indicator: On for link-up, Off for link-down, Blinking for act. Amber for Duplex/Collision indicator: On for Full-duplex, Off for Half-duplex, Blinking for Half-duplex and collision occurred.
Fault Contact	
Relay	Relay output to carry capacity of 1A at 24VDC

Reset Function	
Reset Button	< 5 sec: System reboot, > 5 sec: Factory default
Power	
Redundant Input Power	Dual DC inputs, 12~48VDC on 6-pin terminal block
Power Consumption (Typ.)	≤6Watts, 12-48VDC/0.5A-0.12A
Overload Current Protection	Present
Reverse Polarity Protection	Present
Physical Characteristic	
Enclosure	IP-30, Iron
Dimension (W x D x H)	26.1 (W) x 94.9 (D) x 144.3 (H)mm 1.03 (W) x 3.74 (D) x 5.68 (H) inch
Weight (g)	395 g
Environmental	
Storage Temperature	-40 to 85°C (-40 to 185°F)
Operating Temperature	-40 to 75°C (-40 to 167°F)
Operating Humidity	5% to 95% Non-condensing
Regulatory Approvals	
EMC	CE EMC (EN 55024, EN 55032, EN 61000-6-2, EN 61000-6-4), FCC Part 15 B
EMI	EN 55032, EN 61000-6-4, CISPR32, EN 61000-3-2, EN 61000-3-3, VCCI class A, FCC Part 15 B class A
EMS	EN 55024 (IEC/EN 61000-4-2 (ESD: Contact 4KV, Air 8KV), IEC/EN 61000-4-3 (RS: 3V), IEC/EN 61000-4-4 (EFT Power 0.5KV, Signal 0.5KV), IEC/EN 61000-4-5 (Surge: Power 0.5KV, RJ45 1KV), IEC/EN 61000-4-6 (CS: 3V), IEC/EN 61000-4-8(PFMF), IEC/EN 61000-4-11 (DIP)) EN 61000-6-2 (IEC/EN 61000-4-2 (ESD: Contact 4KV, Air 8KV), IEC/EN 61000-4-3 (RS: 10V), IEC/EN 61000-4-4 (EFT Power 2KV, Signal 1KV), IEC/EN 61000-4-5 (Surge: Power 0.5KV), IEC/EN 61000-4-6 (CS: 10V), IEC/EN 61000-4-8(PFMF), IEC/EN 61000-4-11 (DIP))
Shock	IEC60068-2-27
Free Fall	IEC60068-2-31
Vibration	IEC60068-2-6
Safety	EN 62368-1, UL 61010-1, UL61010-2-201
MTBF	1796601.9604 hrs.
Warranty	5 years